

EPSON
EXCEED YOUR VISION

User's Guide

Multimedia Projector

EB-G5350/G5300

EB-G5200W



EB-G5150/G5100







■ Safety indications

So that you can use the product safely and correctly, symbols are applied in the User's Guide and on the product to indicate possible harm to the user or to others and the risk of damage to property.

The indications and their meaning are as follows. Make sure you understand them properly before reading the guide.

| | |
|--|--|
|  Warning | This symbol indicates information that, if ignored, could possibly result in death or personal injury due to incorrect handling. |
|  Caution | This symbol indicates information that, if ignored, could possibly result in personal injury or physical damage due to incorrect handling. |

■ General information indications

| | |
|---|---|
| Attention | Indicates procedures which may result in damage or injury if sufficient care is not taken. |
|  | Indicates additional information and points which may be useful to know regarding a topic. |
|  | Indicates a page where detailed information regarding a topic can be found. |
|  | Indicates that an explanation of the underlined word or words in front of this symbol appears in the glossary of terms. See the "Glossary" section of the "Appendices".  p.127 |
| Procedure | Indicates operating methods and the order of operations. The procedure indicated should be carried out in the order of the numbered steps. |
| [(Name)] | Indicates the name of the buttons on the remote control or the control panel. Example: [Esc] button |
| "(Menu Name)" | Indicates configuration menu items. Example: "Image" - "Brightness" |

| | |
|---------------------------------------|----------|
| Projector Features | 5 |
| Common Features for all Models | 5 |
| EB-G5350/G5150 Features | 6 |
| Part Names and Functions | 7 |
| Front/Top..... | 7 |
| Base..... | 9 |
| Rear | 10 |
| Control Panel | 12 |
| Remote Control..... | 13 |

Useful Functions

| | |
|--|-----------|
| Correcting Distortion in the Projected Image | 17 |
| Correcting Distortion with Quick Corner | 17 |
| Changing the Projected Image | 19 |
| Automatically Detect Incoming Signals and Change the Projected Image (Source Search)..... | 19 |
| Changing Directly from the Remote Control | 20 |
| Functions for Enhancing Projection | 21 |
| Selecting the Projection Quality (Selecting Color Mode) | 21 |
| Hiding the Image and Sound Temporarily (A/V Mute) | 22 |
| Freezing the Image (Freeze)..... | 22 |
| Changing the Aspect Ratio | 23 |
| Pointer Function (Pointer) | 27 |
| Enlarging Part of the Image (E-Zoom) | 28 |
| Restrictions in the Target Projector when Using Multiple Projectors | 29 |
| Setting the Projector ID | 30 |
| Checking the Projector ID | 30 |
| Setting the Remote Control ID | 31 |
| Correcting Color for Multiple Projectors (Multi-Screen Color Adjustment) | 32 |
| Summary of Correction Procedure..... | 32 |
| Correction Method..... | 32 |
| Security Functions | 34 |
| Managing Users (Password Protect) | 34 |
| Restricting Operation (Control Panel Lock)..... | 36 |
| Anti-Theft Lock..... | 37 |

Configuration Menu

| | |
|--|-----------|
| Using the Configuration Menu | 40 |
| List of Functions | 41 |
| Image Menu..... | 41 |
| Signal Menu..... | 42 |
| Settings Menu..... | 44 |
| Extended Menu..... | 46 |
| Network Menu (EB-G5300/G5200W/G5100 only)..... | 48 |
| Network Menu (EB-G5350/G5150 only) | 50 |
| Info Menu (Display Only) | 63 |
| Reset Menu | 64 |

Troubleshooting

| | |
|--|-----------|
| Using the Help | 66 |
| Problem Solving | 67 |
| Reading the Indicators..... | 67 |
| When the Indicators Provide No Help..... | 70 |

Appendices

| | |
|---|-----------|
| Installation Methods | 80 |
| Cleaning | 81 |
| Cleaning the Projector's Surface | 81 |
| Cleaning the Lens..... | 81 |
| Cleaning the Air Filter | 81 |
| Replacing Consumables | 84 |
| Replacing the Remote Control Batteries | 84 |
| Replacing the Lamp..... | 85 |
| Replacing the Air Filter | 88 |
| Optional Accessories and Consumables | 90 |
| Notes on Transportation | 92 |
| Moving Nearby..... | 92 |
| When Transporting | 92 |
| Saving a User's Logo | 93 |
| Making a WPS (Wi-Fi Protected Setup) Connection with a Wireless LAN Access Point (EB-G5350/G5150 only) | 95 |
| Connection Setup Method..... | 95 |

| | |
|---|------------|
| Screen Size and Distance | 99 |
| Projection Distance for EB-G5350/G5300/G5150/G5100..... | 99 |
| Projection Distance for EB-G5200W..... | 100 |
| Connecting to External Equipment | 101 |
| Connecting to an External Monitor..... | 101 |
| Connecting to External Speakers..... | 101 |
| Removing and Attaching the Projector Lens Unit | 102 |
| Removing..... | 102 |
| Attaching..... | 102 |
| Connecting and Removing USB Devices (EB-G5350/G5150 only) | 104 |
| Connecting USB Devices..... | 104 |
| Reading the USB Indicators..... | 104 |
| Removing USB Devices..... | 104 |
| Inserting and Ejecting SD Cards (EB-G5350/G5150 only) | 105 |
| Inserting..... | 105 |
| Reading the SD Card Access Lamp | 105 |
| Removing..... | 106 |
| Connecting a LAN Cable | 107 |
| Connecting with a USB Cable and Projecting | |
| (USB Display EB-G5350/G5150 only) | 108 |
| Connecting..... | 108 |
| Reading Problem Mail Notification Function | 111 |
| ESC/VP21 Commands | 112 |
| Command List..... | 112 |
| Cable Layouts | 113 |
| Regarding Network Projector (EB-G5350/G5150 only) | 114 |
| About PJLink | 115 |
| List of Supported Monitor Displays | 116 |
| Supported Monitor Displays for EB-G5350/G5300/G5150/G5100..... | 116 |
| Supported Monitor Displays for EB-G5200W..... | 119 |
| Specifications | 122 |
| Projector General Specifications..... | 122 |
| Operating Conditions for the Supplied Software | 124 |
| Appearance | 126 |
| Glossary | 127 |
| Index | 129 |

Common Features for all Models

Ease of use when installed on a ceiling mount

■ Centered lens

You can easily line up the screen and the projector because the lens is located in the center of the projector. Also, because the weight can be easily balanced, this not only benefits ceiling mounts, but also makes it easy to tilt the projector.

■ Equipped with a horizontal and vertical lens shift

Using a lens shift that allows you to adjust the position of the projected image along the horizontal and vertical axis opens up a wide variety of installation locations.

■ Five optional lenses are provided

You can select the best lens according to the projection distance and purpose. The bayonet type allows you to simply and easily exchange and install the optional lenses.

■ A design that adapts to the environment in which it is used

By installing the cable cover supplied, combined with the refined design of the projector, disordered cables can be tidied away.

The control panel installed on the back of the projector makes for easy operability when making necessary settings when installing the projector, and once installation is complete, it can be hidden away using the cable cover.

■ Easy maintenance

You can replace the lamp by opening the cover on the side of the projector and pulling it out horizontally.

You can also replace the air filter by simply sliding it out of or into the front of the projector.

Precise color adjustments

As well as Color Mode, you can also adjust the image's absolute color temperature and the strength of each RGB color. Also, because you can adjust the hue, saturation, and brightness of each RGBCMY, the image can be projected with depth and a color matching in superior detail.

Enhanced security functions

■ Password Protect to restrict and manage users

By setting a password you can restrict who can use the projector.

👉 [p.34](#)

■ Operation Lock restricts button operation on the control panel

You can use this to prevent people changing projector settings without permission

at events, in schools, and so on. 👉 [p.36](#)

■ Equipped with various anti-theft devices

The projector is equipped with the following security devices.

👉 [p.37](#)

- Security slot
- Security cable installation point
- Screw to fix the lens unit removal button

Easy to handle

■ Direct power On/Off

In places where power is managed centrally, such as in a conference room,

the projector can be set to power on and off automatically when the power source to which the projector is connected is switched on or off.

■ No cool down delay

After turning the projector's power off, you can disconnect the projector's power cable without having to wait for the projector to cool down first.

EB-G5350/G5150 Features

You can make effective use of your network by using the supplied "EPSON Projector Software for Meeting & Presentation" to perform efficient and varied presentations and meetings.

Multi-connection

■ Connect a computer to the projector via a network

By connecting the projector to an already constructed network system via a network cable, you can give effective meetings and so on as follows.

- From a conference room, you can open and project a file stored on a computer or file server in another room.
- You can use the Internet.
- You can monitor and control projectors on a network from the computer.

When you install the optional wireless LAN unit in the projector, you can connect to a computer via wireless LAN. [☛ EasyMP Operation Guide](#)

■ Connection with Windows Vista's "Network Projector"

By connecting the projector to a network and using the "Network Projector" function in Windows Vista, multiple users on the network can share the projector.

■ Connect using a USB cable (USB display)

Simply by connecting a commercially available USB cable to a Windows computer you can project images from the computer's screen. [☛ p.108](#)

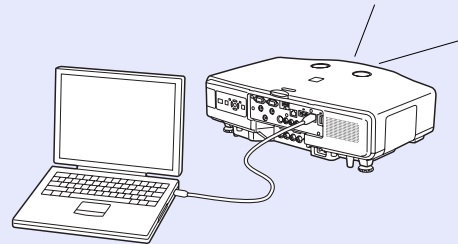

Presentations without a computer

You can make presentations without a computer by using SD cards or USB compatible digital cameras or hard disks. JPEG images, movies, and scenarios stored on SD cards or USB devices can be projected directly.

[☛ EasyMP Operation Guide](#)

Second and third screen projection (Multi-screen display)

You can project a different image from up to four projectors from one computer. This allows you to project a report and so on as a landscape screen. [☛ EasyMP Operation Guide](#)

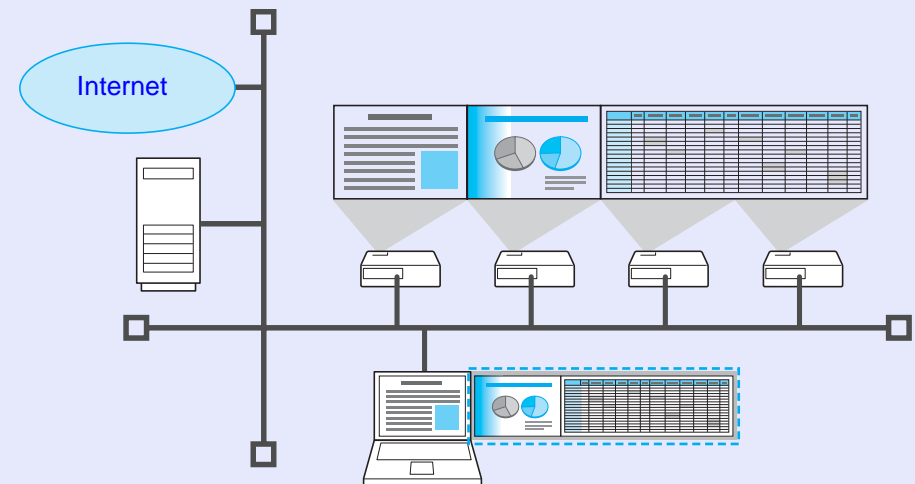

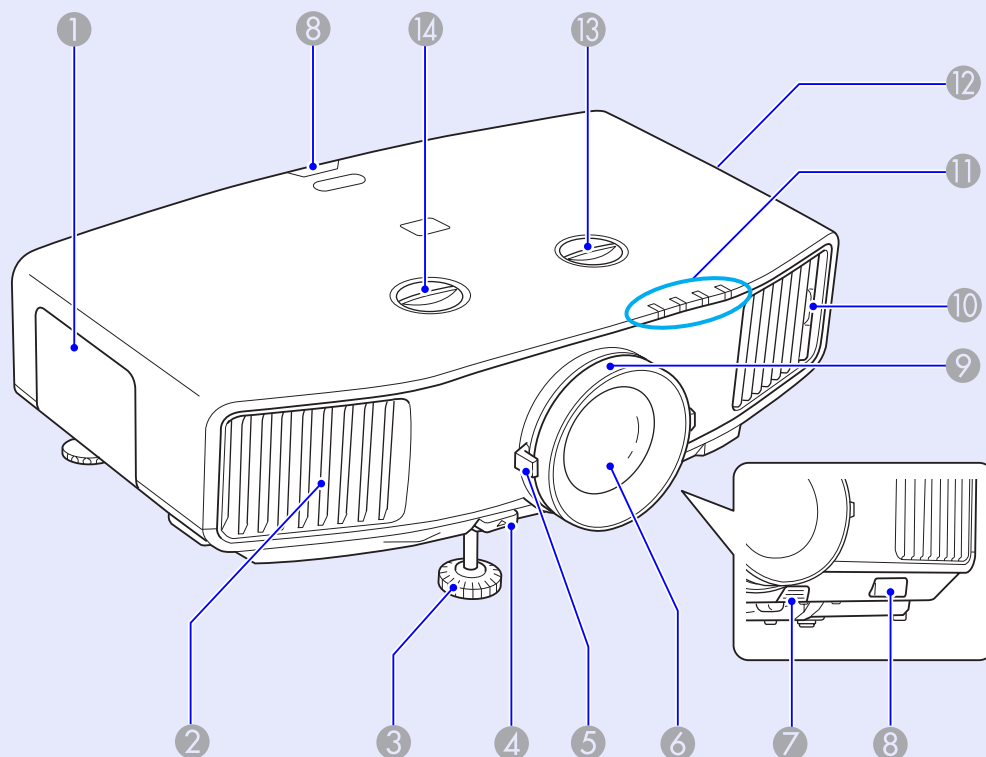

Front/Top

The illustration shows a standard lens attached.



| Name | Function |
|-----------------------------------|---|
| ① Lamp cover | Open this cover when replacing the projector's lamp. p.85 |
| ② Air exhaust vent | Air is used to cool the insides of the projector and vented through this opening. ⚠ Caution Do not place objects that may become warped or otherwise affected by heat near the air exhaust vent and do not put your face or hands near the air exhaust vent while projection is in progress. |
| ③ Front adjustable foot | Extend and adjust the position of the projected image when the projector is placed on a surface such as a desk. Quick Start Guide |
| ④ Foot adjust lever | Pull out the foot lever to extend and retract the front foot. Quick Start Guide |
| ⑤ Zoom ring | Adjusts the image size. Quick Start Guide |
| ⑥ Projection lens | Images are projected through here. |
| ⑦ Lens unit removal button | Press this button to remove the lens unit when replacing lens units. |
| ⑧ Remote Receiver | Receives signals from the remote control. Quick Start Guide |
| ⑨ Focus ring | Adjusts the image focus. Quick Start Guide |
| ⑩ Air filter tab | When cleaning or replacing the air filter, use this tab to pull out the air filter. p.81 , p.88 |
| ⑪ Status indicators | The color of the indicators and whether they are flashing or lit indicate the status of the projector. p.67 |

| Name | Function |
|-------------------------------------|---|
| ⑫ Air intake vent | Air is taken in through this opening to cool the inside of the projector. If dust collects here it can cause the internal temperature of the projector to rise, and this can lead to problems with operation and shorten the optical engine's service life. Clean the air filter regularly.  p.81 |
| ⑬ Vertical lens shift dial | Turn the dial to move the position of the projected image up or down.  Quick Start Guide |
| ⑭ Horizontal lens shift dial | Turn the dial to move the position of the projected image left or right.  Quick Start Guide |

Base

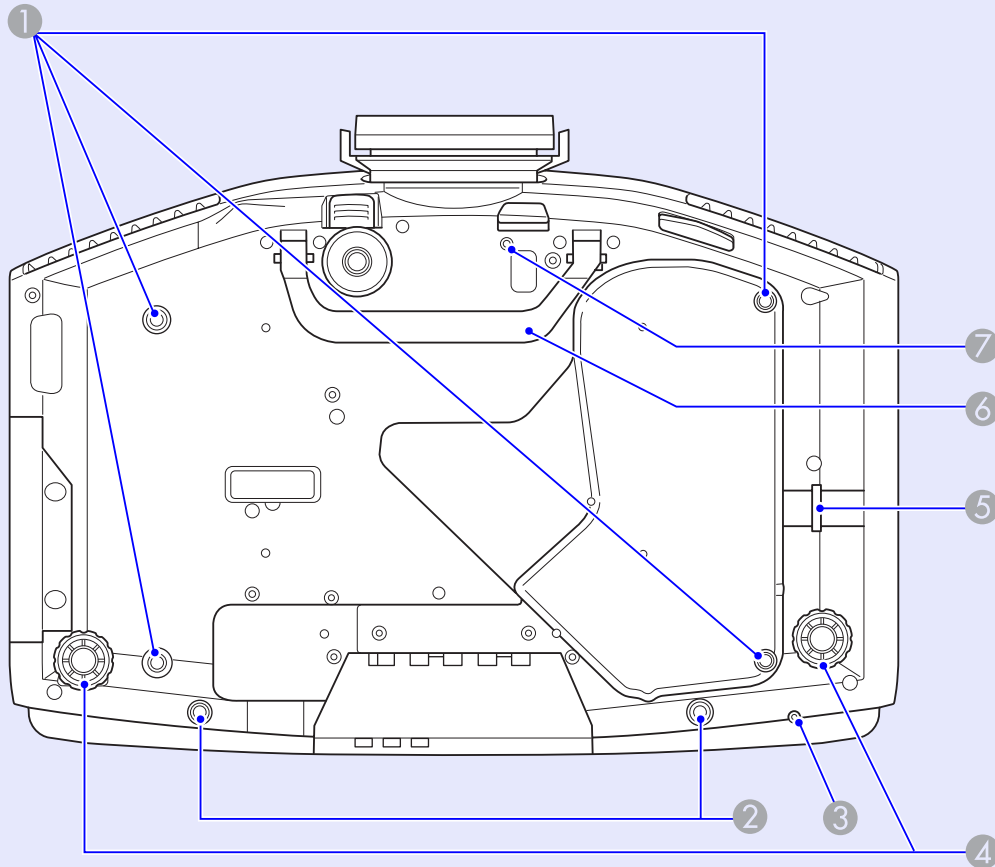



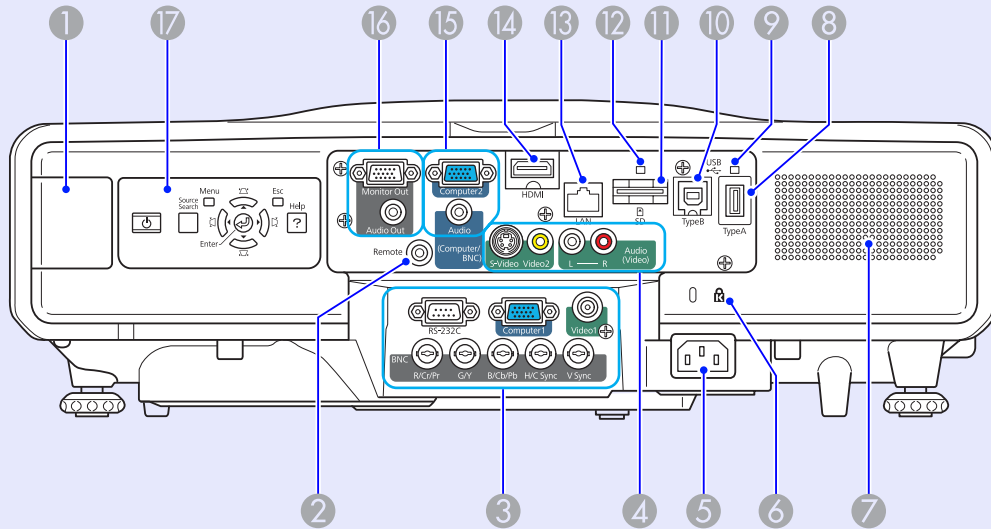

| Name | Function |
|---|---|
| ① Ceiling mount fixing points (4 points) | Attach the optional ceiling mount here when suspending the projector from a ceiling. p.79, 90 |
| ② Screw holes to fix the cable cover | Holes for screws to fix the cable cover in place. Quick Start Guide |
| ③ Screw hole to fix wireless LAN unit | Fixes the the Lens unit removal button using the screw supplied when installing a lens unit. |
| ④ Rear foot | When setup on a desk, turn to extend and retract to adjust the horizontal tilt. Quick Start Guide |
| ⑤ Security cable installation point | Pass a commercially available anti-theft wire lock through here when you want to secure the projector to a fixed object. p.37 |
| ⑥ Handle | Use this handle when carrying the projector. |
| ⑦ Screw hole for the screw to fix the lens unit removal button | When installing a lens unit, use this screw hole to fix the lens unit removal button using the screw supplied. p.37 |

Rear







| Name | Function |
|---|--|
| 1 Wireless LAN unit installation section | Install the optional wireless LAN unit here. Remove the cap when installing. |
| 2 Remote port | Connects the optional remote control cable set and inputs signals from the remote control. When the remote control cable is plugged into this remote port, the remote receiver on the projector is disabled. |
| 3 RS-232C port | When controlling the projector from a computer, connect it to the computer with an RS-232C cable. This port is for control use and should not normally be used. p.112 |
| Computer1 input port | For video signals from a computer and component video signals from other video sources. |
| Video1 input port | For composite video signals from video sources. |
| BNC input port | For video signals from a computer and component video signals from other video sources. |



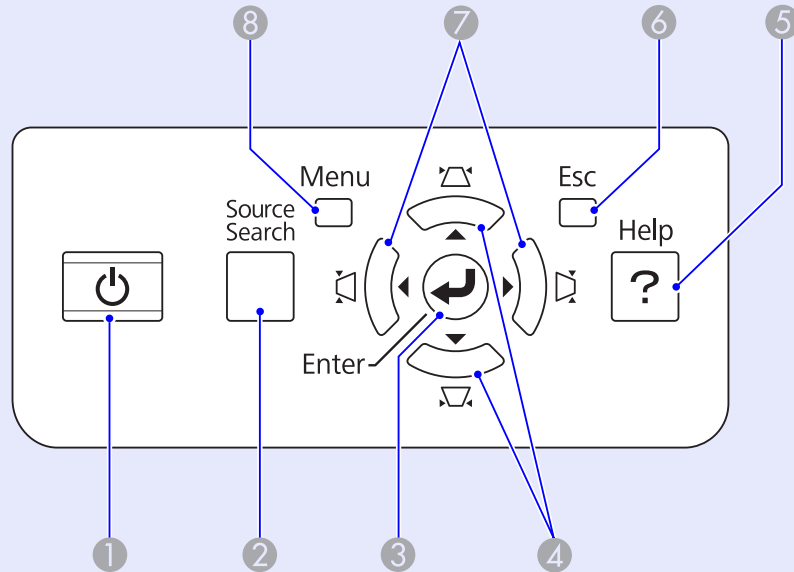

| Name | Function |
|---|--|
| 4 S-Video input port | For S-video signals from video sources. |
| Video2 input port | For composite video signals from video sources. |
| Audio-L/R input port | Connects to the audio out port when you want to output audio from the projector from equipment connected to the S-Video input port or the Video1/2 input port. Quick Start Guide |
| 5 Power inlet | Connects to the power cable. Quick Start Guide |
| 6 Security slot (K) | The security slot is compatible with the Microsaver Security System manufactured by Kensington. p.37 |
| 7 Speaker | |
| 8 USB port (Type A) (EB-G5350/G5150 only) | Connects the memory for compatible digital cameras and USB storage devices, and projects image/movie files and scenarios with PC Free in EasyMP. p.104 |
| 9 USB indicator (EB-G5350/G5150 only) | Indicates the status of USB port (Type A) by flashing or being lit. p.104 |
| 10 USB port (Type B) (EB-G5350/G5150 only) | Connects the projector to a computer with a commercially available USB cable, and the image on the computer is projected. p.108 |
| 11 SD card slot (EB-G5350/G5150 only) | Connects SD memory cards and SDHC (SD High Capacity) cards, and projects image/movie files with PC Free in EasyMP. p.105 |
| 12 SD card access lamp (EB-G5350/G5150 only) | Indicates the access status of the SD card. p.105 |
| 13 LAN port | Connects a LAN cable to connect to a network. p.107 |

| Name | Function |
|---|--|
| 14 HDMI input port | Inputs video signals from HDMI compatible video equipment and computers.  Quick Start Guide |
| 15 Computer2 input port Audio-L/R input port | For video signals from a computer and <u>component video</u> signals from other video sources. Connect to the audio out port when you want to output audio from the projector from equipment connected to the Computer1/2 input port or the BNC input port. When you are using USB display and want to output sound from the projector, you must make a connection to your computer's audio output.(EB-G5350/G5150 only)  Quick Start Guide |
| 16 Monitor Out port Audio Out port | Outputs to an external monitor the image signal from the computer connected to the Computer1/2 input port or the BNC input port. This is not available for component video signals or other signals being input to any port other than the Computer1/2 input port or the BNC input port.  p.101 Outputs the sound of the image currently being projected to external speakers.  p.101 |
| 17 Control panel |  p.12 |

Control Panel







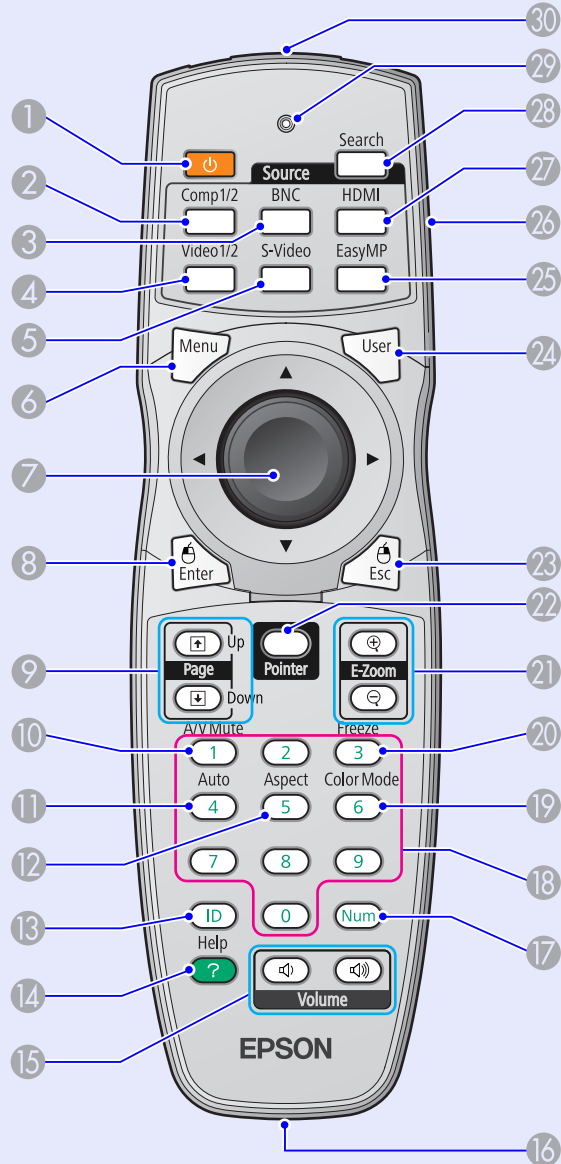

| Name | Function |
|--------------------------|---|
| ① [Power] button | Turns the projector power on or off.  Quick Start Guide |
| ② [Source Search] button | Changes to the next input source that is connected to the projector and is sending an image.  p.19 |
| ③ [Enter] button | If pressed during projection of computer signal images, it automatically adjusts the tracking, synchronization, and position to project the optimum image. When a configuration menu or a help screen is displayed, it accepts and enters the current selection and moves to the next level.  p.40 |









| Name | Function |
|---|---|
| ④ [∇/\blacktriangle] [$\blacktriangledown/\blacktriangle$] buttons | Corrects keystone distortion. In the following cases, however, these buttons only have the [\blacktriangle] and [\blacktriangledown] functions. <ul style="list-style-type: none"> •When the projected image is being sent through a network connection •When the PC Free function is being used for projection If pressed when a configuration menu or a help screen is displayed, these buttons select menu items and setting values.  Quick Start Guide, p.40 |
| ⑤ [Help] button | Displays and closes the help screen which shows you how to deal with problems if they occur.  p.66 |
| ⑥ [Esc] button | Stops the current function. If pressed when a configuration menu is displayed, it moves to the previous menu level.  p.40 |
| ⑦ [$\blacktriangleleft/\blacktriangleright$] [$\blacktriangleright/\blacktriangleleft$] buttons | Corrects keystone distortion. In the following cases, however, these buttons only have the [\blacktriangleleft] and [\blacktriangleright] functions. <ul style="list-style-type: none"> •When the projected image is being sent through a network connection •When the PC Free function is being used for projection If pressed when a configuration menu or a help screen is displayed, these buttons select menu items and setting values.  Quick Start Guide, p.40 |
| ⑧ [Menu] button | Displays and closes the configuration menu.  p.40 |



Remote Control



| Name | Function |
|------------------------|---|
| 1 [Power] button | Turns the projector power on or off. Quick Start Guide |
| 2 [Computer1/2] button | Changes to images from the Computer1 or Computer2 input ports. p.20 |
| 3 [BNC] button | Changes to images from the BNC input port. p.20 |
| 4 [Video1/2] button | Changes to images from the Video1 or Video2 input ports. p.20 |
| 5 [S-Video] button | Changes to images from the S-video input port. p.20 |
| 6 [Menu] button | Displays and closes the configuration menu. p.40 |
| 7 [Pointer] button | When a configuration menu or help screen is displayed, it selects menu items and setting values. p.40 , p.66 When using the optional wireless mouse receiver, tilting this button moves the pointer in the direction (eight possible directions) tilted. |
| 8 [Enter] button | When a configuration menu or a help screen is displayed, it accepts and enters the current selection and moves to the next level. p.40 , p.66 Acts as a mouse's left button when using the optional wireless mouse receiver. |

| Name | Function |
|--------------------------------|---|
| 9 [Page] buttons (↑) (↓) | Moves to the next/previous slide when the input source is EasyMP and a PowerPoint file or a scenario is being projected.(EB-G5350/G5150 only)  EasyMP Operation Guide When using the optional wireless mouse receiver, you can change the PowerPoint file page during projection by pressing the page up/page down buttons. |
| 10 [A/V Mute] button | Turns the video and audio on or off.  p.22 |
| 11 [Auto] button | If pressed during projection of computer signal images, it automatically adjusts the tracking, synchronization, and position to project the optimum image. |
| 12 [Aspect] button | The <u>aspect ratio</u> changes each time the button is pressed.  p.23 |
| 13 [ID] button | Press to set the remote control ID.  p.31 |
| 14 [Help] button | Displays and closes the help screen which shows you how to deal with problems if they occur.  p.66 |
| 15 [Volume] buttons (←) (→) | (←) Decreases the volume. (→) Increases the volume.  Quick Start Guide |
| 16 Remote port | Connects the optional remote control cable set and inputs signals from the remote control. When the remote control cable is plugged into this remote port, the remote receiver is disabled. |
| 17 [Num] button | Use this button to enter passwords, IP addresses from the "Network menu", and so on.  p.34 |

| Name | Function |
|--------------------------------|---|
| 18 Numeric buttons | Use this button to enter passwords, remote control IP settings, IP addresses from the "Network menu", and so on.  p.34 , p.31 |
| 19 [Color Mode] button | Each time the button is pressed, the color mode changes.  p.21 |
| 20 [Freeze] button | Images are paused or unpaused.  p.22 |
| 21 [E-zoom] buttons (+) (-) | (+) Enlarges the image without changing the projection size. (-) Reduces parts of images that have been enlarged using the [+] button.  p.28 |
| 22 [Pointer] button | Press to activate the on screen pointer.  p.27 |
| 23 [Esc] button | Stops the current function. If pressed when a configuration menu is displayed, it moves to the previous level.  p.40 Acts as a mouse's right button when using the optional wireless mouse receiver. |
| 24 [User] button | Press to assign a frequently used item from the six available Configuration menu items. By pressing the button the assigned menu item selection/adjustment screen is displayed, allowing you to make one-touch settings/adjustments.  p.44 "Test pattern" is assigned as the default setting. |
| 25 [EasyMP] button | Changes to the EasyMP image.(EB-G5350/G5150 only)  p.20 When using EB-G5200W/G5300/G5100, this does not function even if the button is pressed. |

| Name | Function |
|--|---|
| 26 ID switch | Use this switch to enable (On)/disable (Off) ID settings for the remote control.  p.29 |
| 27 [HDMI] button | Changes to images from the HDMI input port.  p.20 |
| 28 [Source Search] button | Changes to the next input source that is connected to the projector and is sending an image.  p.19 |
| 29 Indicators | A light is emitted when outputting remote control signals. |
| 30 Remote control light-emitting area | Outputs remote control signals. |



Useful Functions

This chapter explains useful functions for giving presentations and so on, and the security functions.

Correcting Distortion in the Projected Image 17

- Correcting Distortion with Quick Corner17

Changing the Projected Image 19

- Automatically Detect Incoming Signals and Change the Projected Image (Source Search).....19
- Changing Directly from the Remote Control20

Functions for Enhancing Projection 21

- Selecting the Projection Quality (Selecting Color Mode).....21
- Hiding the Image and Sound Temporarily (A/V Mute).....22
- Freezing the Image (Freeze).....22
- Changing the Aspect Ratio.....23
 - Changing methods23
 - Changing the aspect for video equipment images23
 - Changing the aspect for computer images/HDMI images (For EB-G5350/G5300/G5150/G5100 only).....24
 - Changing the aspect for computer images/HDMI images (For EB-G5200W)25
- Pointer Function (Pointer)27

- Enlarging Part of the Image (E-Zoom) 28

Restrictions in the Target Projector when Using Multiple Projectors29

- Setting the Projector ID 30
- Checking the Projector ID 30
- Setting the Remote Control ID 31

Correcting Color for Multiple Projectors (Multi-Screen Color Adjustment)32

- Summary of Correction Procedure 32
- Correction Method 32

Security Functions34

- Managing Users (Password Protect)..... 34
 - Type of Password Protect 34
 - Setting Password Protect..... 34
 - Entering the Password..... 36
- Restricting Operation (Control Panel Lock) 36
- Anti-Theft Lock 37
 - Installing the wire lock..... 37
 - Anti-theft projection lens 38

There are two ways to correct distortion in projected images as below.

- Quick Corner

This allows you to manually correct each of the four corners of the projected image separately.  p.17

- H/V-Keystone

This allows you to manually correct distortion in the horizontal and vertical directions independently. H/V-Keystone correction is ideal for fine-tuning Keystone distortion. You can perform easy corrections by using the [↖/▲], [↘/▼], [↙/◀], and [↗/▶] buttons on the projector's control panel.  **Quick Start Guide**

These two methods cannot be used together. When the "Keystone" correction method is selected from the Configuration menu, the correction method you choose is assigned to the control panel [↖/▲], [↘/▼], [↙/◀], and [↗/▶] buttons. The default setting for "Keystone" is set to "H/V-Keystone", when [↖/▲], [↘/▼], [↙/◀], and [↗/▶] buttons are pressed, H/V-Keystone correction is carried out.

Because "Quick Corner" and "H/V-Keystone Correction" can be carried out while projecting a test pattern, you do not need to make preparations by connecting a computer or other equipment.

Correcting Distortion with Quick Corner

Procedure

- 1 Press the [Menu] button on the projector, and then from the configuration menu select Settings Keystone.  "Using the Configuration Menu" p.40

Using the remote control

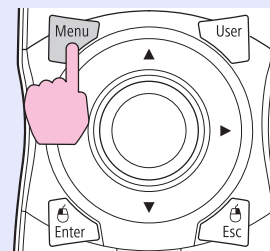

Using the control panel

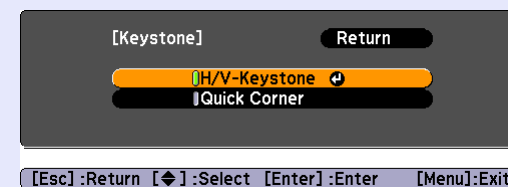
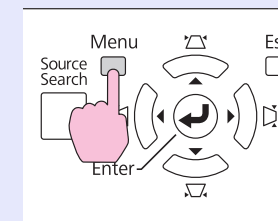

2

Select "Quick Corner", and then press the [Enter] button.

Press the [Enter] button again to display the selection screen from which you can select one of four corners.

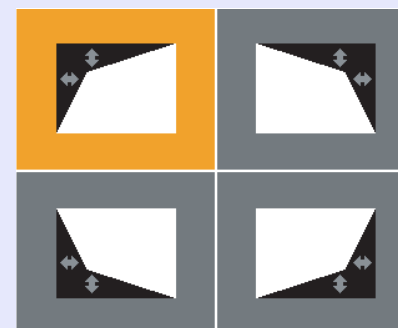

- 3** Use the [⊙] button on the remote control or the [↖/↗], [↘/↙], [↵/↶], and [↷/↸] buttons on the control panel to select the corner you want to adjust, and then press the [Enter] button.

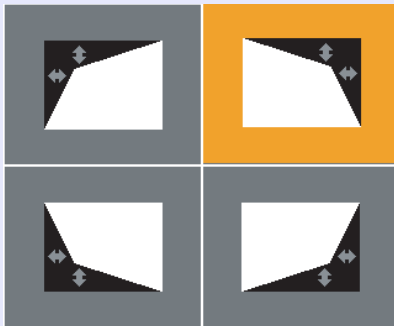

- 4** To adjust the shape, use the [⊙] button on the remote control or the [↖/↗], [↘/↙], [↵/↶], and [↷/↸] buttons on the control panel.

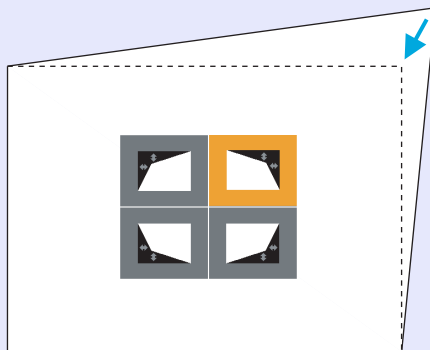

If the screen below is displayed during the correction, this means that you have reached the correction amount limit.

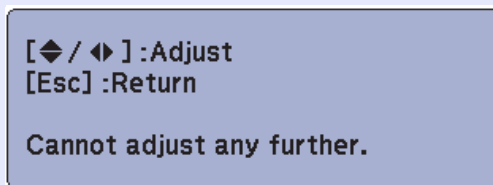

- 5** Repeat procedures 3 and 4 as needed to adjust any remaining corners.

- 6** When you are done, press the [Esc] button to exit the correction menu.

Because the correction method was changed to "Quick Corner" from "Keystone" in the Configuration menu, when [↖/↗], [↘/↙], [↵/↶], and [↷/↸] buttons are pressed later, the screen for selecting the corner in procedure 2 is displayed. Change "Keystone" from the Configuration menu to "H/V-Keystone" if you want to correct H/V-Keystone when pressing the [↖/↗], [↘/↙], [↵/↶], and [↷/↸] buttons on the control panel.



If the [Esc] button is held down for about two seconds while correcting with Quick Corner, the following screen is displayed.

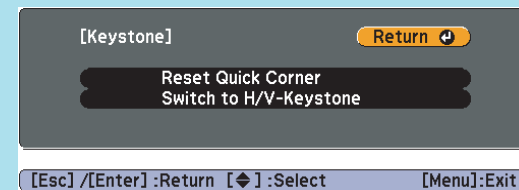

Reset Quick Corner: Resets the result of Quick Corner corrections.
 Switch to H/V-Keystone: Switches the correction method to H/V-Keystone. 🖱️ p.44

You can change the projected image in the following two ways.

- Changing by Source Search
The projector automatically detects signals being input from connected equipment, and the image being input from the equipment is projected.
- Changing directly
You can use the remote control buttons to change to the target input port.

Automatically Detect Incoming Signals and Change the Projected Image (Source Search)

You can project the target image quickly as input ports with no image signal being input are ignored when you change by pressing the [Source Search] button.

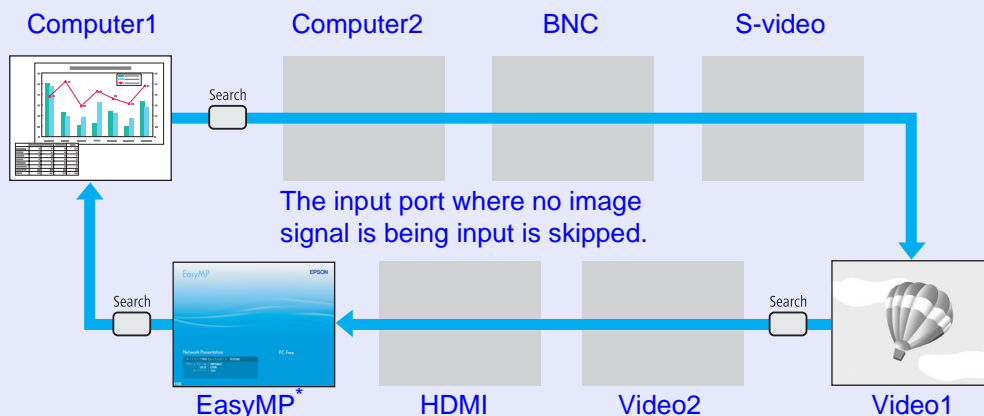

*Only EB-G5350/G5150 changes to EasyMP.

Procedure

When your video equipment is connected, start playback before beginning this operation.

Using the remote control

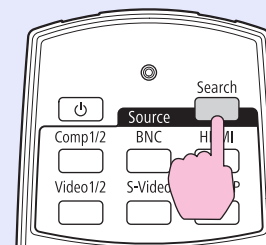

Using the control panel

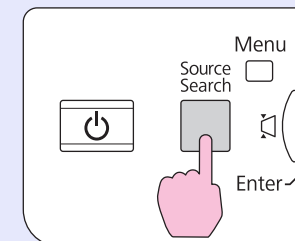

When two or more pieces of equipment are connected, press the [Source Search] button until the target image is projected.



The following screen showing the status of image signals is displayed when only the image that the projector is currently displaying is available, or when no image signal can be found. You can select the input port where the connected equipment you want to use is projecting. If no operation is performed after about 10 seconds, the screen closes.

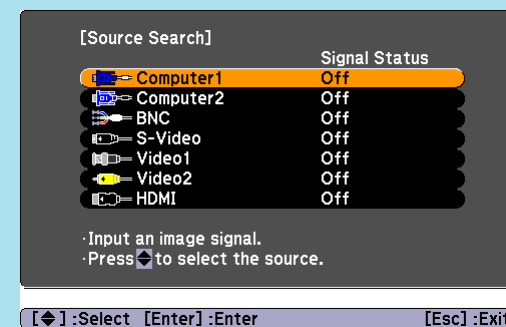

Changing Directly from the Remote Control

You can change directly to the target image by pressing the following buttons on the remote control.

Remote control

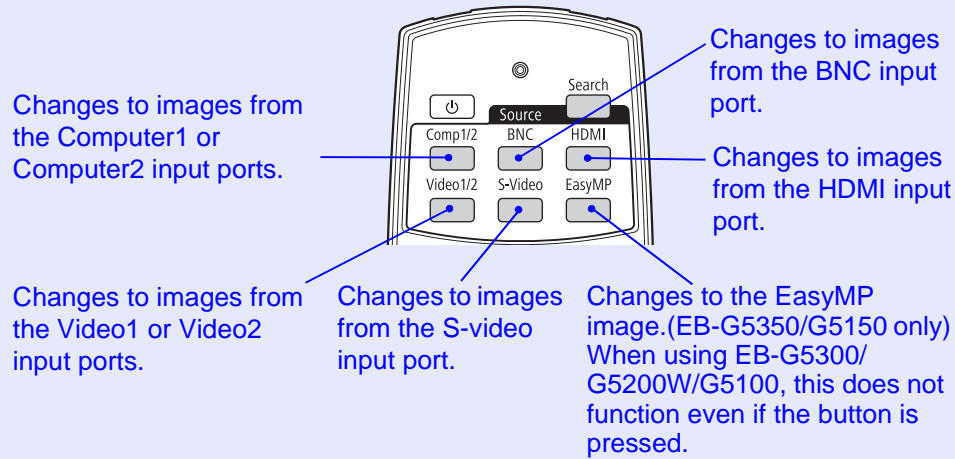

Selecting the Projection Quality (Selecting Color Mode)

You can easily obtain the optimum image quality simply by selecting the setting that best corresponds to your surroundings when projecting. The brightness of the image varies depending on the mode selected.

| Mode | Application |
|-------------------|---|
| Dynamic | Ideal for use in a bright room. This is the brightest mode, and reproduces shadow tones well. If you are worried about image delays during projection for games involving speed, try turning setting "Progressive" from the configuration menu to "Off". p.42 |
| Presentation1 | Ideal for making presentations using color materials in a bright room. |
| Text | Ideal for making presentations using black-and-white materials in a bright room. |
| Theatre | Ideal for watching films in a dark room. Gives images a natural tone. |
| Photo | (When computer images are input) Ideal for projecting still pictures, such as photos, in a bright room. The images are vivid and brought into contrast. |
| Sports | (When component video, S-video, or composite video images are input) Ideal for watching TV programmes in a bright room. The images are vivid and brought to life. |
| sRGB [®] | Ideal for images that conform to the sRGB color standard. |
| Blackboard | Even if you are projecting onto a blackboard (greenboard), this setting gives your images a natural tint, just like when projecting onto a screen. |

| Mode | Application |
|------------|--|
| Customized | Select "Customized" to adjust "R,G,B,C,M,Y" from "Color Adjustment" in the configuration menu. p.41 |

Procedure

Remote control

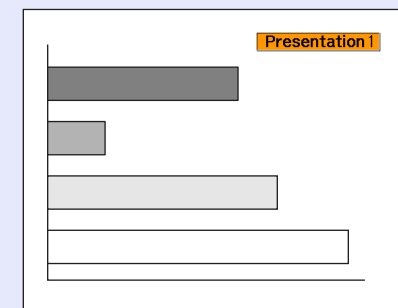
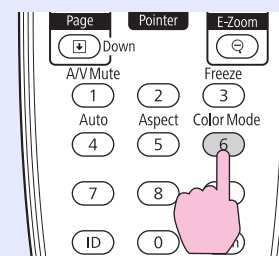

Each time you press the button, the color mode name is displayed on the screen and the color mode changes.

If you press the button while the color mode name is displayed on the screen, it changes to the next color mode.



The color mode can also be set using "Color Mode" in the "Image" menu from the configuration menu. p.41

Hiding the Image and Sound Temporarily (A/V Mute)

You can use this when you want to focus the audience's attention on what you are saying, or if you do not want to show details such as when you are changing between files during presentations from a computer.

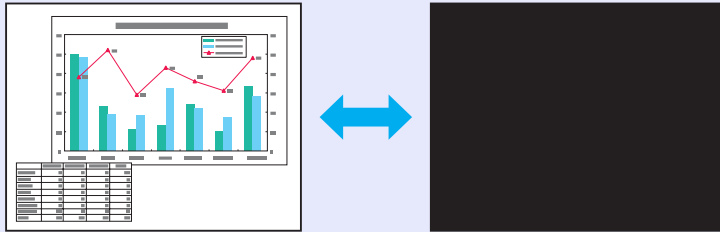

Procedure

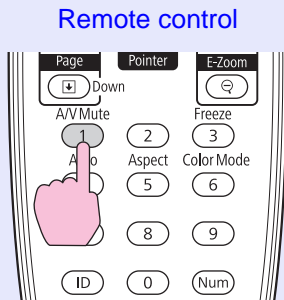

Each time you press the button, A/V Mute turns on or off.



- **If you use this function when projecting moving images, the images and sound continue to be played back by the source, and you cannot return to the point where A/V Mute was activated.**
- **You can choose to display black, blue, or logo as the A/V mute display using the "Extended"- "Display"- "A/V Mute" setting from the configuration menu. p.46**

Freezing the Image (Freeze)

When the moving image on the screen is frozen, the image continues to project, so you can project a moving image one frame at a time like a still photo. Also, you can perform operations such as changing between files during presentations from a computer without projecting any images if the freeze function is activated beforehand.

Procedure

Remote control

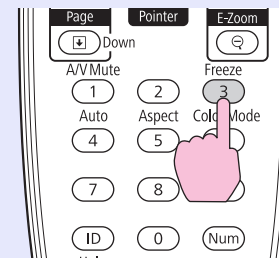

Each time you press the button, Freeze turns on or off.



- **Audio does not stop.**
- **The image source continues to playback the moving images even while the screen is frozen, and so it is not possible to resume projection from the point where it was paused.**
- **If the [Freeze] button is pressed while the configuration menu or a help screen is displayed, the menu or help screen being displayed is cleared.**
- **Freeze still works while E-Zoom is being used.**

Changing the Aspect Ratio

Change the aspect ratio when video equipment is connected so that images that have been recorded in digital video or onto DVDs can be viewed in 16:9 wide-screen format. Change the aspect ratio when projecting computer images at full size.

The changing methods and the types of aspect ratio are as follows.

Changing methods

Procedure

Remote control

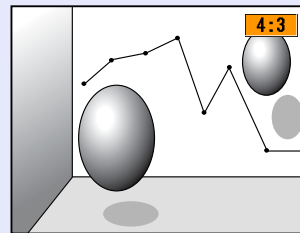
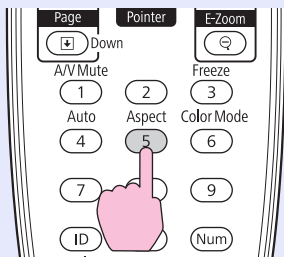

Each time you press the button, the aspect name is displayed on the screen and the aspect changes.

If you press the button while the aspect name is displayed on the screen, it changes to the next aspect mode.



The color mode can also be set using "Aspect" in the "Signal" menu from the configuration menu. p.42

Changing the aspect for video equipment images

EB-G5350/G5300/G5150/G5100 only

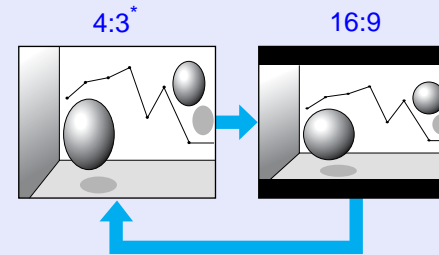

* When 720p/1080i/1080p signals are input, the display is zoomed to a 4:3 ratio.

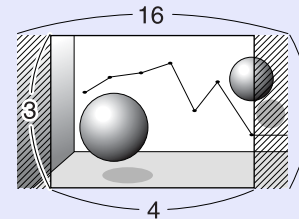

For EB-G5200W

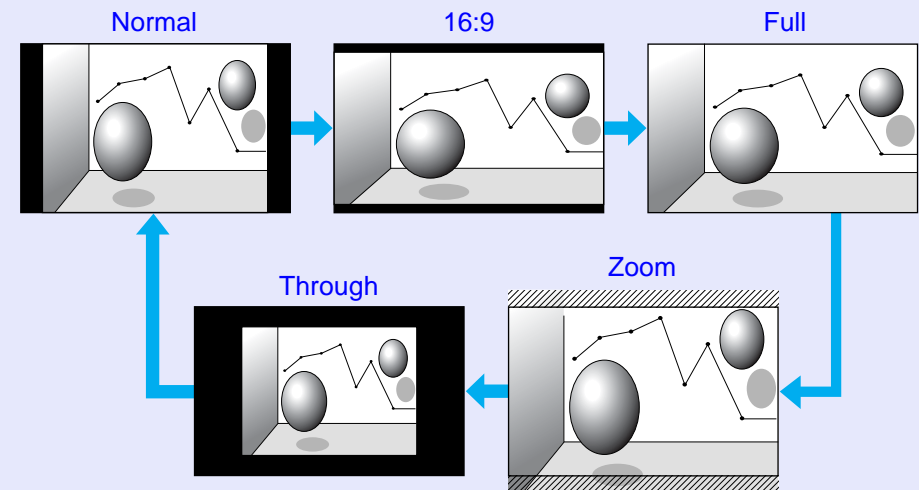

■ **Changing the aspect for computer images/HDMI images (For EB-G5350/G5300/G5150/G5100 only)**

You can change projections of computer images or images input from the HDMI input port as follows.

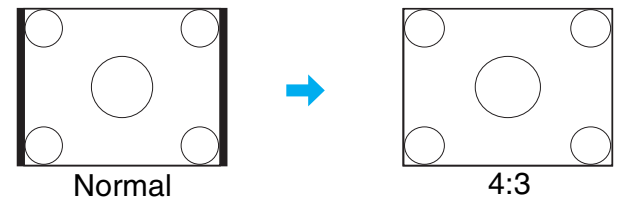
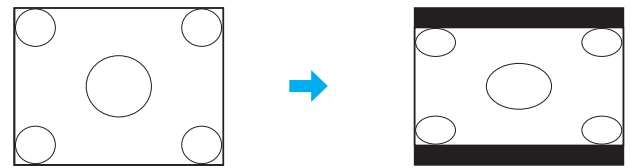
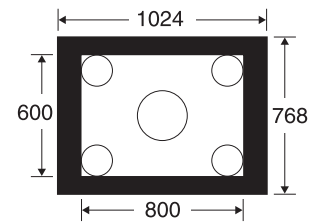
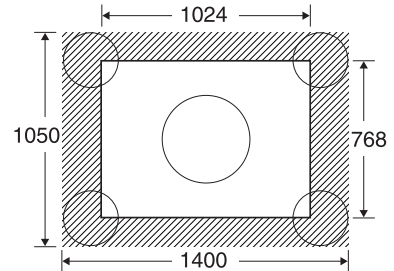
| Set Values | | Operation | Projection example | |
|----------------|--|--|--|---|
| Normal | When images are input from the Computer1/2 or BNC input ports | Projects to the full projection size retaining the aspect of the input image. | | |
| Auto | When images are input from the HDMI input port | Projects in an appropriate aspect based on information from the signal being input. | | |
| 4:3 | | Projects to the full projection size at an aspect of 4:3. This is ideal for when you want to project images at an aspect of 5:4 (1280 × 1024) to the full projection size. | When a 1280 × 1024 signal is input  | |
| 16:9 | | Projects at a 16:9 aspect. This is ideal for projecting at full screen size when using a 16:9 screen. | When a 1280 × 1024 signal is input  | |
| Through | | Projects at the resolution of the input image size to the center of the screen. This is ideal for projecting clear images. If the image resolution exceeds 1024 × 768, the edges of the image are not projected. | When an 800 × 600 signal is input  | When a 1400 × 1050 signal is input  |



When projecting computer images, if parts of the image are missing or it cannot project everything, set "Wide" or "Normal" in "Resolution" from the configuration menu depending on the size of the computer panel. [p.42](#)

■ Changing the aspect for computer images/HDMI images (For EB-G5200W)

You can change the aspect of projections of computer images or images input from the HDMI input port as follows. For EB-G5200W the projection size is 1280 x 800 dots (aspect ratio 16:10) due to WXGA panel resolution. When projecting on to 16:9 screens, set the aspect to "16:9".

| Set Values | | Operation | Projection example |
|---------------|--|---|---------------------------------------|
| Normal | When images are input from the Computer1/2 or BNC input ports | Projects to the full projection size retaining the aspect of the input image. | When a 1024 × 768 signal is input |
| Auto | When images are input from the HDMI input port | Projects in an appropriate aspect based on information from the signal being input. | When a 1280 × 800 signal is input |
| 16:9 | | Projects to the full projection size at an aspect of 16:9. | When a 1024 × 768 signal is input |

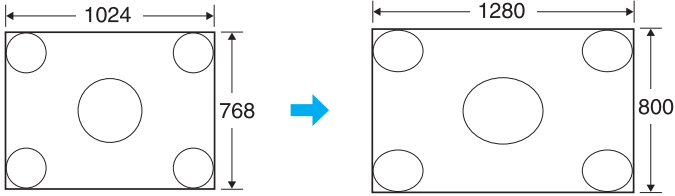
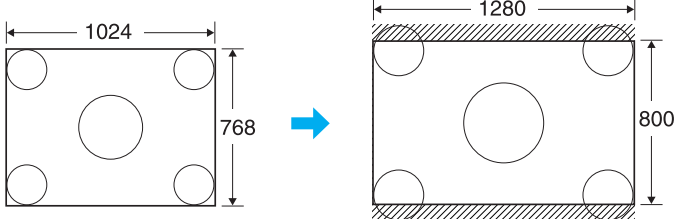
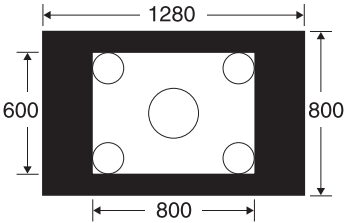
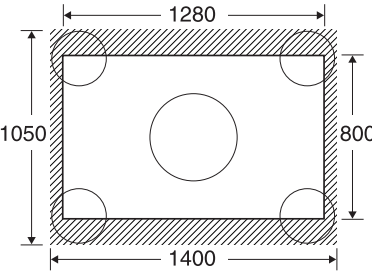
| Set Values | Operation | Projection example | |
|----------------|--|---|--|
| Full | Project at full size. | When a 1024 × 768 signal is input  | |
| Zoom | Projects the input image at the lateral direction aspect size as it is. Parts that extend beyond the projection size are not projected. | When a 1024 × 768 signal is input  | |
| Through | Projects at the resolution of the input image size to the center of the screen. This is ideal for projecting clear images. If the image resolution exceeds 1280 × 800, the edges of the image are not projected. | When an 800 × 600 signal is input  | When a 1400 × 1050 signal is input  |



When projecting computer images, if parts of the image are missing or it cannot project everything, set "Wide" or "Normal" in "Resolution" from the configuration menu depending on the size of the computer panel.  p.42

Pointer Function (Pointer)

This allows you to move a pointer icon on the projected image, and helps you draw attention to the area you are talking about.

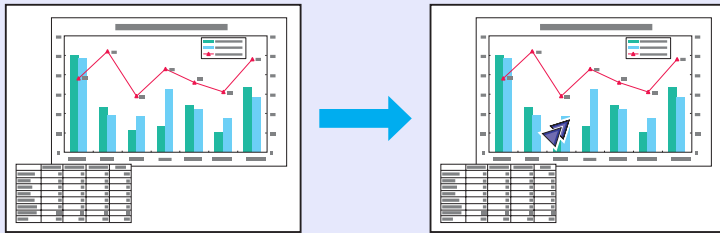

Procedure

1 Display the pointer.

Remote control

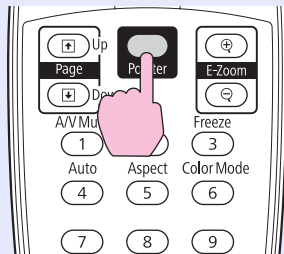

Each time you press the button, the pointer appears or disappears.

2 Move the pointer icon.

Remote control

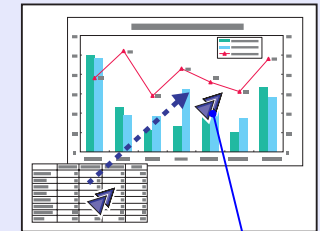
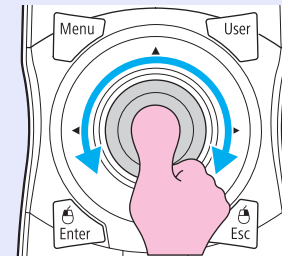

Pointer icon



You can choose from three different kinds of pointer icon (↖ · ✕ · ↗) in "Settings" - "Pointer Shape" from the configuration menu. p.44

Enlarging Part of the Image (E-Zoom)

This is useful when you want to expand images to see them in greater detail, such as graphs and tables.

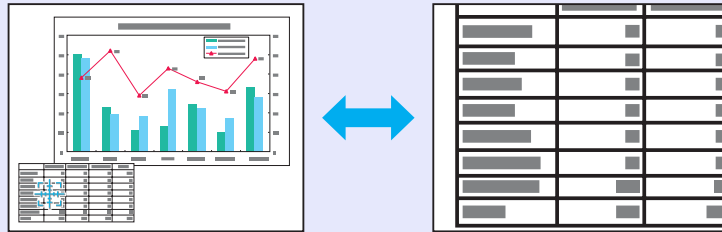

Procedure

1 Start E-Zoom.

Remote control

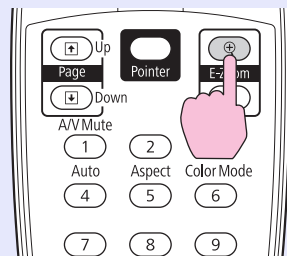

2 Move the cross to the area of the image that you want to enlarge.

Remote control

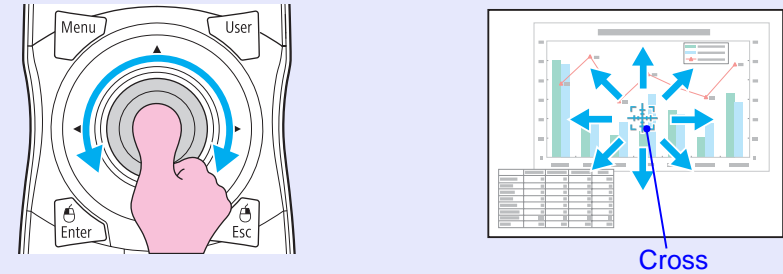

3 Enlarge.

Remote control

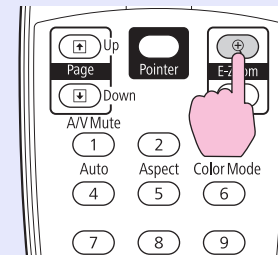

Each time the button is pressed, the area is expanded. You can expand quickly by holding the button down. You can reduce the enlarged image by pressing the [◀] button. Press the [Esc] button to cancel.



- *The enlargement ratio appears on the screen. The selected area can be enlarged to between 1 to 4 times in 25 incremental steps.*
- *Tilt the [◂] button to scroll the image.*
- *If E-Zoom is selected when Progressive or Noise Reduction are being performed, the function currently being performed is cancelled.*

Restrictions in the Target Projector when Using Multiple Projectors



When an ID is set for the projector and the remote control, you can use the remote control to operate only the projector with a matching ID. This is very useful when managing multiple projectors.

You can set an ID for the projector within a range of "1" to "9". The default value is "Off", and you can operate with the remote control regardless of the remote control's ID setting.

You can set an ID for the remote control within a range of "0" to "9". The default value is "0", and you can operate with the remote control regardless of the projector's ID setting. Also, if there is an ID switch on the side of the remote control, and this switch is set to "Off", you can operate all projectors by remote control regardless of the ID setting for the projector or the remote control.

| Can operate remote control | Cannot operate remote control | Can operate remote control | Can operate remote control | Can operate remote control |
|--|---|--|--|--|
| ○ | ✗ | ○ | ○ | ○ |
| <p>Projector ID: 1</p> <p>ID switch: On Remote control ID: 1</p> | <p>Projector ID: 1</p> <p>ID switch: On Remote control ID: 3</p> | <p>Projector ID: 1</p> <p>ID switch: Off Remote control ID: 3</p> | <p>Projector ID: Off</p> <p>ID switch: On Remote control ID: 1</p> | <p>Projector ID: 1</p> <p>ID switch: On Remote control ID: 0</p> |
| Example when projector ID and remote control ID match, and remote control switch is On | Example when projector ID and remote control ID do not match, and remote control switch is On | Example when projector ID and remote control ID do not match, and remote control switch is Off | Example when projector ID is Off | Example when remote control ID is 0, and ID switch is On |

Setting the Projector ID

Procedure

- 1 During projection, press the [Menu] button on the projector and select "Extended" - "Projector ID" from the configuration menu. "Using the Configuration Menu" p.40

Using the remote control

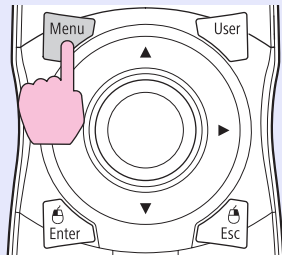

Using the control panel

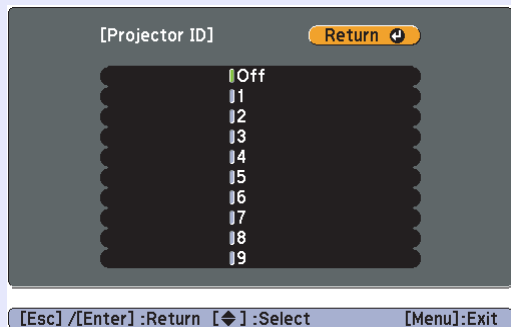
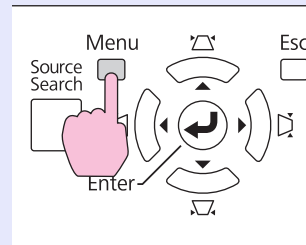

Checking the Projector ID

Use the following procedure to check the projector ID.

Procedure

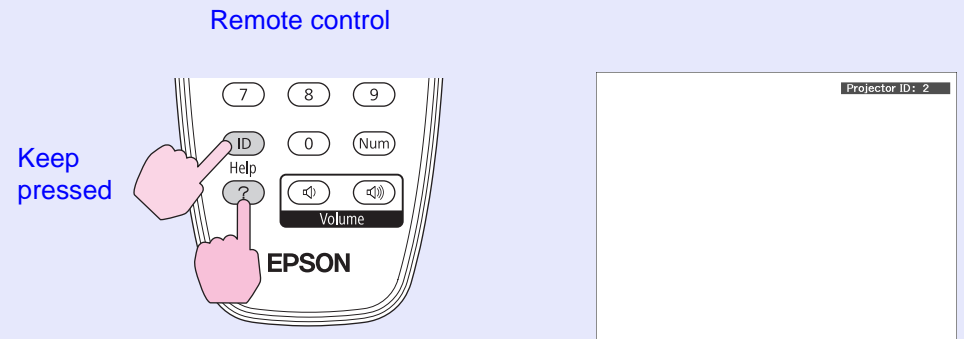

During projection, while holding the [ID] button, press the [Help] button to display the current projector ID on the screen.

- 2 Choose the ID you want to set and press the [Enter] button.
- 3 Press the [Menu] button to close the configuration menu.

Setting the Remote Control ID

When the ID switch on the side of the remote control is Off, remote control ID is disabled, and you can operate with the remote control regardless of the projector's ID setting. When the ID switch is set to On, remote control ID is enabled, and you can define which projector to operate. Also, perform settings for the remote control ID with the ID switch set to On.

Procedure

- 1 Set the remote control ID switch to On.

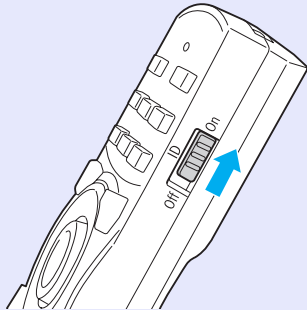

- 2 While holding the [ID] button, press a number button to select a number to match the ID of the projector you want to operate.

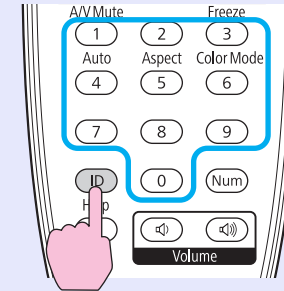

Keep pressed

Once this setting has been made, the projector that can be operated by remote control is limited.



The remote control ID setting is saved in the remote control. Even if the remote control batteries are removed to replace them and so on, the stored ID setting is retained. However, if the batteries are left out for a long time, it is reset to the default value (ID0).



When multiple projectors are lined up and projecting images, you can correct the brightness and color tone of each projector's image with multi-screen color adjustment so that the colors of images from each projector match closely.

In some cases the brightness and color tone may not match completely even after correction.

Summary of Correction Procedure

When multiple projectors are setup and you need to make corrections, use the following procedure to correct one projector at a time.

1. Set the projector ID and the remote control ID

To limit operation to one target projector, set a Projector ID for the target projector, and set the same ID for the remote control. p.29

2. Correct the color difference

You can carry out color correction when projecting from multiple projectors. You can adjust from black to white in five stages called levels 1 to 5, and in each of these 5 levels you can adjust the following two points.

- Correcting brightness
You can correct the image brightness to make them all equal.
- Correcting color
You can adjust the image color to make them match more closely by using "Color Correct. (G/R)" and "Color Correct. (B/Y)".

Correction Method

After setting up the projectors, correct the brightness and tone for each projector to reduce the differences.

Procedure



Press the [Menu] button and select "Extended" - "Multi-screen" from the configuration menu.

"Using the Configuration Menu" p.40



Select the level to be corrected in "Adjustment Level".

- Each time a level is selected, the pattern of the level selected is displayed.
- You can start correcting from any level, usually you can make it darker or lighter by correcting 1 to 5 or 5 to 1.



Correct the brightness with "Brightness Correct.".

- When you select level 5, it adjusts to the darkest image from multiple projectors.
- When you select level 1, it adjusts to the brightest image from multiple projectors.
- When you select level 2 to 4, it adjusts to the mid-range brightness image from multiple projectors.
- Each time the [Enter] button is pressed the image displayed changes between the pattern display and the actual image, and you can check the correction results and make corrections in the actual image.

4 Correcting "Color Correct. (G/R)" and "Color Correct. (B/Y)".

Each time the [Enter] button is pressed the image displayed changes between the pattern display and the actual image, and you can check the correction results and make corrections in the actual image.

5 Repeat procedures 2 to 4 until corrections are finished.

6 When all corrections are finished, press the [Menu] button to close the configuration menu.

The projector has the following enhanced security functions.

- Password protect
You can limit who can use the projector.
- Operation Lock
You can prevent people changing the settings on the projector without permission.
- Anti-Theft Lock
The projector is equipped with various types of anti-theft security devices.

Managing Users (Password Protect)

When Password Protect is activated, people who do not know the password cannot use the projector to project images even if the projector power is on. Furthermore, the user's logo that is displayed when you turn on the projector cannot be changed. This acts as an anti-theft device as the projector cannot be used even if it is stolen. At the time of purchase, Password Protect is not activated.

■ Type of Password Protect

The following three kinds of password protect settings can be made according to how the projector is being used.

1. Power on protect

When "Power On Protect" is "On", the password must be entered whenever the projector is turned on after it has been disconnected from the power supply it was connected to the last time the password was entered. If the correct password is not entered, projection does not start.

2. User's logo protect

Even if someone tries to change the user's logo set by the owner of the projector, it cannot be changed. When "User's Logo Protect" is set to "On", the following setting changes for the user's logo are prohibited.

- Capturing a user's logo
- Settings for "Display Background", "Startup Screen", and "A/V Mute" from "Display" in the configuration menu.

3. Network Protect

When "Network Protect" is set to "On" setting changes for "Network" in the configuration menu are prohibited.

■ Setting Password Protect

Use the following procedure to set Password Protect.

Procedure



During projection, hold down the [Freeze] button for about five seconds.

The password protect setting menu is displayed.

Remote control

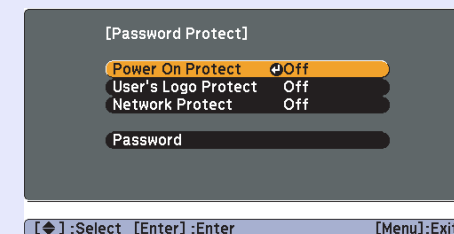
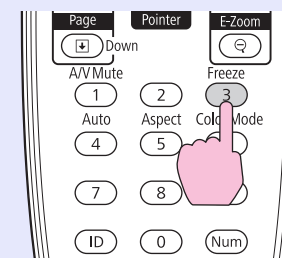

- **If Password Protect is already activated, you must enter the password.**
If the password is entered correctly, the password protect setting menu is displayed.  **"Entering the Password" p.36**
- **When the password is set, stick the password protect sticker in a visible position on the projector as a further theft deterrent.**

2 Turn on "Power On Protect".

- (1) Select "Power On Protect", and then press the [Enter] button.
- (2) Select "On", and then press the [Enter] button.
- (3) Press the [Esc] button.

3 Turn on "User's Logo Protect".

- (1) Select "User's Logo Protect", and then press the [Enter] button.
- (2) Select "On", and then press the [Enter] button.
- (3) Press the [Esc] button.

4 Turn on "Network Protect".

- (1) Select "Network Protect", and then press the [Enter] button.
- (2) Select "On", and then press the [Enter] button.
- (3) Press the [Esc] button.

5 Set the password.

- (1) Select "Password", and then press the [Enter] button.
- (2) The message "Change the password?" is displayed, select "Yes" and then press the [Enter] button. The default setting for the password is "0000". Change this to your own desired password. If you select "No", the screen shown in step 1 is displayed again.
- (3) While holding down the [Num] button, enter a four digit number using the numeric buttons. The number entered is displayed as "* * * *". When you enter the fourth digit, the confirmation screen is displayed.

Remote control

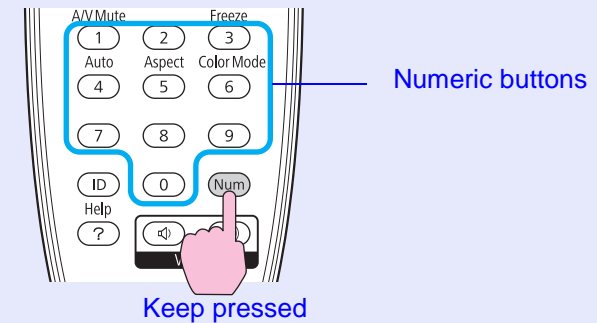

- (4) Re-enter the password.
The message " Password accepted." is displayed.
If you enter the password incorrectly, a message is displayed prompting you to re-enter the password.

■ Entering the Password



When the password entry screen is displayed, enter the password using the numeric buttons on the remote control.

Procedure

While holding down the [Num] button, enter the password by pressing the numeric buttons.

When you enter the correct password, projection begins.

Attention

- *If an incorrect password is entered three times in succession, the message "The projector's operation will be locked." is displayed for about five minutes, and then the projector switches to standby mode. If this happens, disconnect the power plug from the electrical outlet and then reinsert it and turn the projector's power back on. The projector displays the password entry screen again so that you can enter the correct password.*
- *If you have forgotten the password, make a note of the "Request Code: xxxxx" number that appears on the screen and contact the nearest address provided in the Support and Service Guide.*
 [Epson Projector Contact List](#)
- *If you continue to repeat the above operation and input the wrong password thirty times in succession, the following message is displayed and the projector does not accept any more password entries. The projector's operation will be locked. Contact Epson as described in your documentation.*  [Epson Projector Contact List](#)

Restricting Operation (Control Panel Lock)

Do one of the following to lock the operation buttons on the control panel.

- Full lock
All of the buttons on the control panel are locked. You cannot perform any operations from the control panel, including turning the power on or off.
- Partial lock
All of the buttons on the control panel, except for the [⏻] button, are locked.

This is useful at events or shows when you want to deactivate all buttons and only project, or at schools when you want to limit button operation. The projector can still be operated using the remote control.

Procedure



During projection, press the [Menu] button and select "Settings" - "Control Panel Lock" from the configuration menu.  "Using the Configuration Menu" p.40

Using the remote control

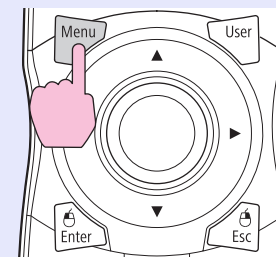

Using the control panel

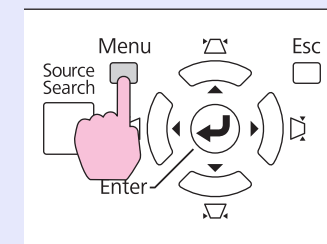

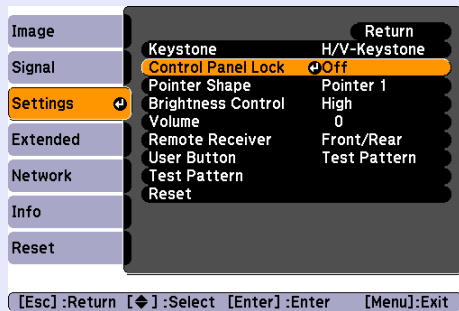

2 Select either "Full Lock" or "Partial Lock".

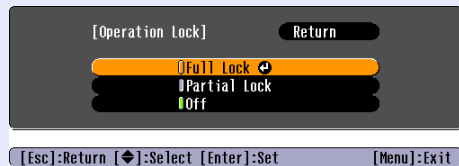

3 Select "Yes" when the confirmation message is displayed.

The control panel buttons are locked according to the setting you chose.



You can release the control panel lock by one of the following two methods.

- *From the remote control, select "Off" in "Settings" - "Operation Lock" from the configuration menu.*
- *Press and hold down the [Enter] button on the control panel for about seven seconds, a message is displayed and the lock is released.*

Anti-Theft Lock

As the projector is often setup on ceiling mounts and left in rooms unattended, it is possible that someone may try and take the projector, so the projector includes the following security devices.

- Security slot
The security slot is compatible with the Microsaver Security System manufactured by Kensington. You can find details about the Microsaver Security System on the Kensington homepage <http://www.kensington.com/>.
- Security cable installation point
A commercially available theft-prevention wire lock can be passed through the installation point to secure the projector to a desk or pillar.
- Screw to fix the lens unit removal button
The lens removal button can be locked so that the projection lens cannot be removed immediately with the screw supplied.

■ Installing the wire lock

Pass an anti-theft wire lock through the installation point. See the documentation supplied with the wire lock for locking instructions.

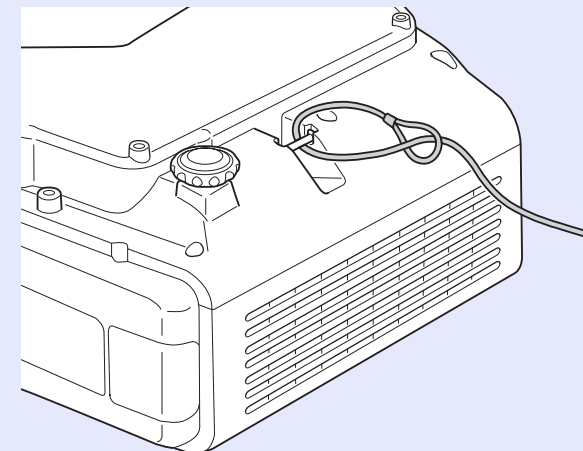

■ Anti-theft projection lens

The bayonet type allows you to simply and easily exchange the projector's lens. If you are concerned about security, this is a useful anti-theft device as, once it is locked with the screw supplied, it cannot be quickly removed.

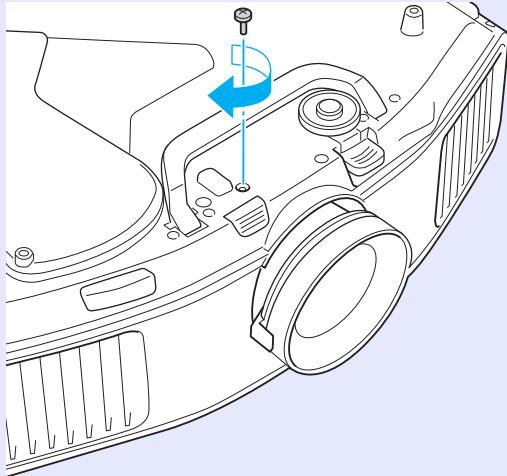



Configuration Menu

This chapter explains how to use the configuration menu and its functions.

Using the Configuration Menu 40

List of Functions 41

- **Image Menu**41
- **Signal Menu**42
- **Settings Menu**44
- **Extended Menu**46
- **Network Menu (EB-G5300/G5200W/G5100 only)**.....48
- **Network Menu (EB-G5350/G5150 only)**.....50
 - Notes on operating the network menu..... 51
 - Soft keyboard operations..... 51
 - Basic Menu..... 52
 - Wireless LAN menu (only when the optional wireless LAN unit is installed).....53

- Security menu (Only available when the optional wireless LAN unit is installed) 55
- Wired LAN Menu 59
- Mail menu 60
- Others menu 61
- Reset Menu 62

- **Info Menu (Display Only)** 63
- **Reset Menu**..... 64

1 Selecting from the top menu

Top menu



Guide

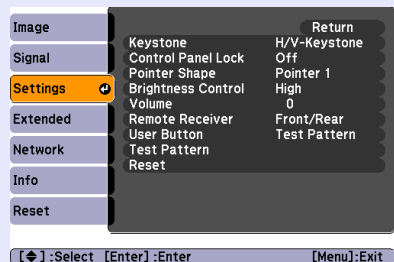
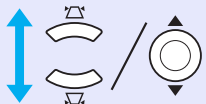

Sub menu (Settings)

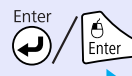
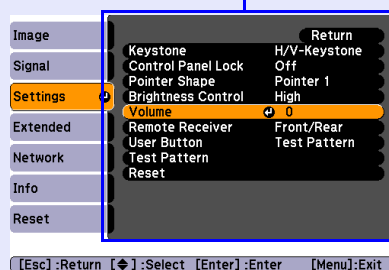

3 Changing the selected item

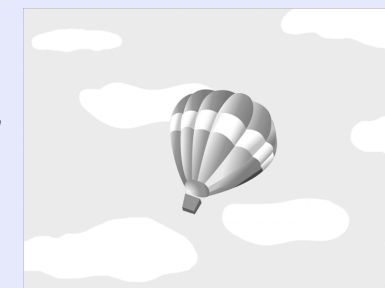
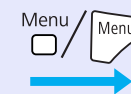
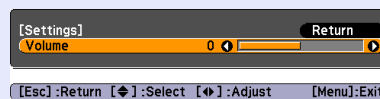

Buttons used

Using the control panel

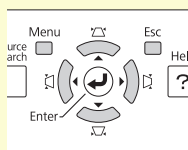

Using the remote control

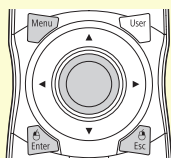

Select the setting to change

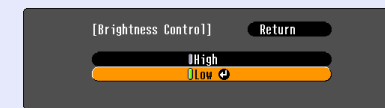
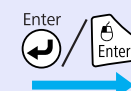
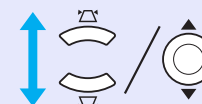
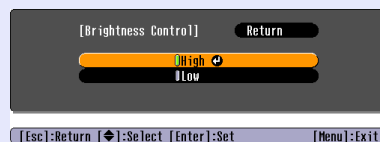

[Esc]:Return [Left Arrow]:Select [Enter]:Set [Menu]:Exit

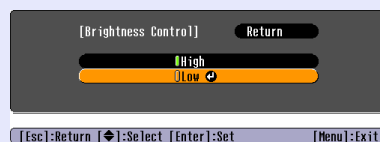
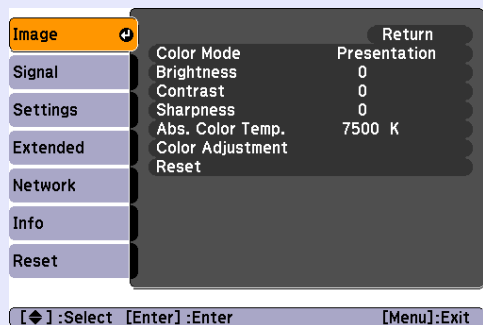

Image Menu



Items that can be set vary depending on the image signal currently being projected as shown in the following screen shots. Setting details are saved for each image signal.

Computer image/EasyMP (EB-G5350/G5150 only)



Component video▶▶/Composite video▶▶/S-video▶▶



| Sub Menu | Function |
|-------------------|--|
| Color Mode | You can select the quality of the image to suit your surroundings.  p.21 |
| Brightness | You can adjust the image brightness. |
| Contrast▶▶ | You can adjust the difference between light and shade in the images. |
| Color Saturation | You can adjust the color saturation for the images. |
| Tint | (Adjustment is only possible when NTSC signals are being input if you use composite video/S-video.) You can adjust the image tint. |
| Sharpness | You can adjust the image sharpness. |
| Abs. Color Temp. | (This item cannot be selected if "sRGB▶▶" is selected as the "Color Mode" setting from the "Image" menu.) You can adjust the overall tint of the image. You can adjust tints in 10 stages from 5000 K to 10000 K. When a high value is selected the image becomes tinged with blue, when a low value is selected the image becomes tinged with red. |
| Color Adjustment | You can make adjustments by choosing one of the following(This item cannot be selected if "sRGB▶▶" is selected as the "Color Mode" setting from the "Image" menu.) Red, Green, Blue: You can adjust the saturation of each color individually. (This item cannot be displayed if "Customized" is selected as the "Color Mode" setting from the "Image" menu.) R, G, B, C, M, Y: You can adjust the hue, saturation, and brightness of each color R (red), G (green), B (blue), C (cyan), M (magenta), Y (yellow) individually. (This item is only displayed if "Customized" is selected as the "Color Mode" setting from the "Image" menu.) |
| Reset | You can reset all adjustment values for the "Image" menu functions to their default settings. To return all menu items to their default settings, see  p.64 |

Signal Menu

Items that can be set vary depending on the image signal currently being projected as shown in the following screen shots. Setting details are saved for each image signal.

You cannot make settings on the "Signal" menu when the source is EasyMP.(EB-G5350/G5150 only)

Computer image

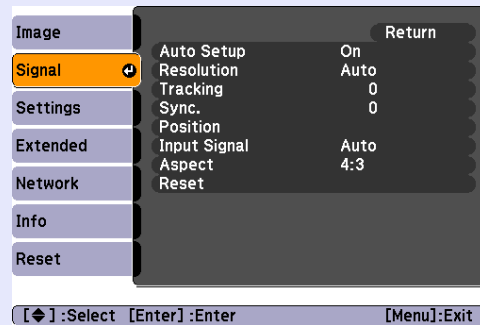

When the signal status is input from the HDMI input port

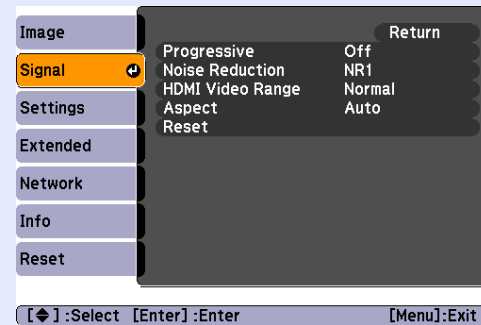



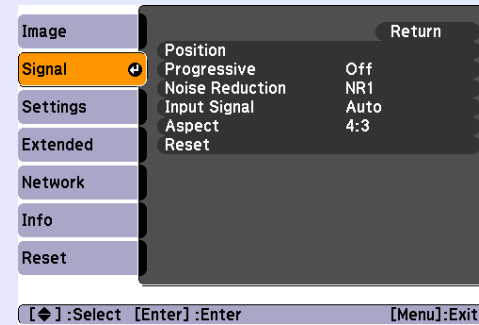

Component video

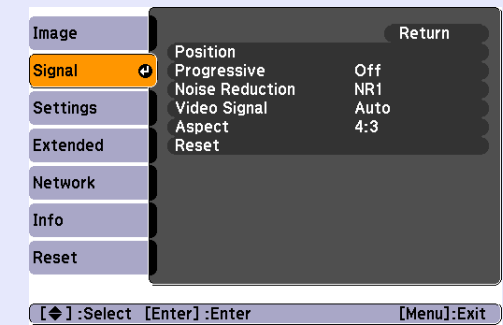

Composite video/S-video







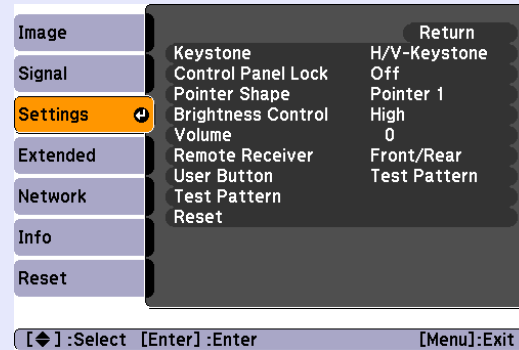

| Sub Menu | Function |
|-----------------|--|
| Auto Setup | You can select whether or not (On/Off) the image is automatically adjusted to the optimum state when the input signal changes.  p.73 |
| Resolution | When set to "Auto", the resolution of the input signal is automatically identified. If the projected images cannot be projected correctly when set to "Auto", such as some of the image is missing, adjust to "Wide" depending on the connected computer for wide screens, or set to "Normal" for 4:3 or 5:4 screens. When the connected computer is fixed, you can select "Manual" and specify the resolution. |
| Tracking | You can adjust computer images when vertical stripes appear in the images.  p.73 |
| Sync. | You can adjust computer images when flickering, fuzziness, or interference appear in the images.  p.73 |
| Position | You can adjust the display position up, down, left, and right when a part of the image is missing so that all of the image is projected. |
| Progressive | (Signals from the HDMI input port (excluding digital RGB) or component video can only be adjusted when 480i/576i/1080i signals are being input.) Off: IP conversion is carried out for each field in the screen. This is ideal for viewing images with a large amount of movement. Video: This is ideal for viewing general video images. Film/Auto: By automatically converting movie films, CG, animated images, and so on recorded in 24/30 frames to the optimum progressive signal via 2-3 pull-down, it is possible to recreate the natural feel of the original image. |
| Noise Reduction | (This cannot be set when a digital RGB signal is input) Smoothes out rough images. There are two modes. Select your favorite setting. It is recommended that this is set to "Off" when viewing image sources in which noise is very low, such as for DVDs. |

| Sub Menu | Function |
|------------------|---|
| HDMI Video Range | (This cannot be set when a digital RGB signal is input) When the projector's HDMI input port is connected to a DVD player and so on, the projector's video range is set according to the DVD player's video range setting. |
| Input Signal | You can select the input signal from the Computer1/2 input port or the BNC input port. If set to "Auto" the input signal is set automatically according to the connected equipment. If colors do not appear correctly when set to "Auto", select the appropriate signal according to the connected equipment. |
| Video signal | You can select the input signal from Video1/2 input port. If set to "Auto", video signals are recognized automatically. If interference appears in the image or a problem occurs such as no image is being projected when set to "Auto", select the appropriate signal according to the connected equipment. |
| Aspect | You can set the <u>aspect ratio</u> for projected images.  p.23 |
| Reset | You can reset all adjustment values on the "Signal" menu to their default settings, except for "Input Signal". To return all menu items to their default settings, see  p.64 |

Settings Menu





| Sub Menu | Function |
|--------------------|---|
| Keystone | <p>You can correct keystone distortion in images.</p> <p>H/V Keystone : Corrects horizontal and vertical keystone distortion. Select one of "V-Keystone" or "H-Keystone". Use the [↖/↗], [↘/↙], [↗/↖], and [↘/↙] buttons on the control panel to perform similar corrections to "V-Keystone" and "H-Keystone".</p> <p>Quick Corner: Selects and corrects the four corners of the projected image.  p.17</p> |
| Control Panel Lock | You can use this to restrict operation of the projector's control panel.  p.36 |
| Pointer shape | <p>You can select the shape of the pointer.  p.27</p> <p>Pointer 1:  Pointer 2:  Pointer 3: </p> |
| Brightness Control | <p>You can set the lamp brightness to one of two settings.</p> <p>Select "Low" if the images being projected are too bright such as when projecting images in a dark room or onto a small screen. When "Low" is selected, the amount of electricity consumed and the lamp's operating life are changed as follows, and fan rotation noise during projection is reduced. Electrical consumption: about a 14% decrease, lamp life: about 1.5 times longer</p> |
| Volume | You can adjust the volume. Setting details are saved for each image signal. |
| Remote Receiver | <p>You can limit the reception of the operation signal from the remote control.</p> <p>When you want to prohibit operation by remote control, or if the remote receiver has a fluorescent light too close to it, you can make settings to deactivate the remote receiver you do not want to use or that is experiencing interference.</p> |

| Sub Menu | Function |
|--------------|--|
| User Button | You can select the item assigned from the configuration menu with the remote control's [User] button. By pressing the button the assigned menu item selection/adjustment screen is displayed, allowing you to make one-touch settings/adjustments. You can assign one of the following six items to the [User] button. Brightness Control, Info, Progressive, Test Pattern, Multi-screen, or Resolution |
| Test Pattern | When the projector is setup, a test pattern is displayed so that you can adjust the projection without connecting other equipment. While the test pattern is displayed, zoom, focus adjustments, and keystone correction can be performed. To cancel the test pattern, press the [Esc] button on the remote control or the control panel. |
| Reset | You can reset all adjustment values on the "Settings" menu to their default settings, except for "User Button". To return all menu items to their default settings, see  p.64 |

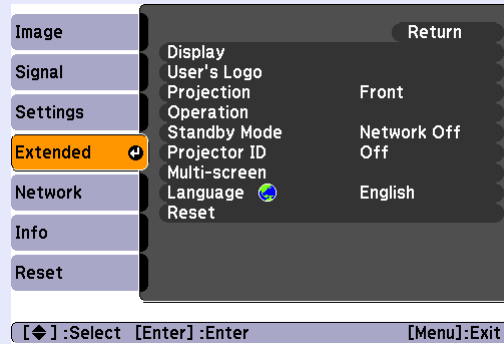
Extended Menu



| Sub Menu | Function |
|--------------|--|
| Display | <p>You can make settings related to the projector's display.</p> <p>Messages: You can set whether or not (On/Off) to display the source name when you change the input source, the color mode name when you change the color mode, a message when no image signal is input, and so on.</p> <p>Display Background*: You can set the screen status for when no image signal is available to "Black", "Blue", or "Logo".</p> <p>Startup Screen*: You can set whether or not (On/Off) the startup screen (the image projected when starting the projector) is displayed.</p> <p>A/V Mute*: You can set the screen displayed during A/V Mute as "Black", "Blue", or "Logo".</p> |
| User's Logo* | You can change the user's logo that is displayed as a background and displayed during A/V Mute.  p.93 |
| Projection | <p>You can set from the following according to the way the projector is setup.  p.79</p> <p>Front "Front/Ceiling" "Rear" "Rear/Ceiling"</p> <p>You can change the setting as follows by pressing down the [A/V Mute] button on the remote control for about five seconds.</p> <p>Front" ↔ "Front/Ceiling"</p> <p>Rear" ↔ "Rear/Ceiling"</p> |

* When "User's Logo Protect" is set to "On" in "Password Protect", settings relating to user's logo cannot be changed. You can make changes after setting "User's Logo Protect" to "Off".  [p.34](#)

| Sub Menu | Function |
|--------------|--|
| Operation | <p>Direct Power On: You can set whether or not (On/Off) to enable Direct Power On. When it is set to "On" and the projector power cable is connected to an electrical outlet, be aware that sudden surges of electricity when power comes back on after a power outage may cause the projector to turn on automatically.</p> <p>Sleep Mode: When set to "On", this automatically stops projection when no image signal is being input and no operations are carried out.</p> <p>Sleep Mode Timer: When Sleep Mode is set to "On", you can set the time before the projector automatically turns off within a range of 1 to 30 minutes.</p> <p>High Altitude Mode: Set to "On" when using the projector above an altitude of 1500 m.</p> <p>BNC Sync Termination: Set the termination for the signal from the BNC input port. This should usually be set to "Off". Set to "On" when analog (75Ω) termination such as for switchers is necessary.</p> |
| Standby mode | <p>You can use network monitoring and control functions while the projector is in standby mode when this is set to "Network On". You can use SNMP to monitor and control the status of the projector over the network, or by using the "EMP Monitor" software supplied with this product.</p> |
| Projector ID | Set the ID within a range of "1" to "9". "Off" indicates that no ID is set. p.30 |
| Multi-screen | <p>You can adjust the hue and brightness of each projected image when multiple projectors are lined up and projecting. p.32</p> <p>Adjustment Level: You can adjust from black to white in five stages called levels 1 to 5, and in each of these 5 levels you can adjust "Brightness Correct." and "Color Correct".</p> <p>Brightness Correct.: Corrects the difference in the brightness of each product.</p> <p>Color Correct. (G/R) / Color Correct. (B/Y): You can correct the difference in the color of each product.</p> |
| Language | You can set the language for message displays. |
| Reset | <p>You can reset "Display^{*1}" and "Operation^{*2}" from the "Extended" menu to their default settings. To return all menu items to their default settings, see p.64</p> |



*1 When "User's Logo Protect" is set to "On" in "Password Protect", settings relating to user's logo cannot be changed. You can make changes after setting "User's Logo Protect" to "Off". [p.34](#)

*2 Except for "High Altitude Mode".

Network Menu (EB-G5300/G5200W/G5100 only)

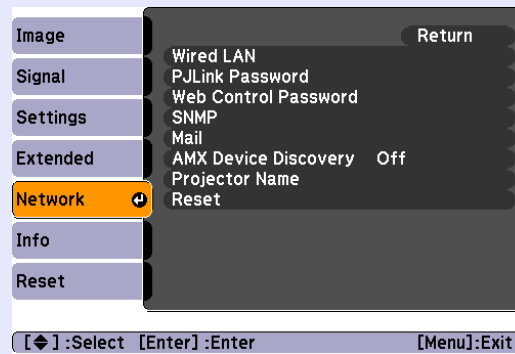
When "Network Protect" is set to "On" in "Password Protect", a message is displayed and the settings cannot be changed. You can make changes after setting "Network Protect" to "Off".  [p.34](#)



| Sub Menu | Function |
|----------------------|--|
| Wired LAN | <p>You can make network settings.</p> <p>DHCP: You can set whether or not (On/Off) to use DHCP. If this is set to "On" you cannot set any more addresses.</p> <p>IP Address: You can input the IP address assigned to the projector.*¹ You can enter a number from 0 to 255 in each field of the address. However, the following IP addresses cannot be used. 0.0.0.0, 0.x.x.x, 127.x.x.x, 224.0.0.0 to 255.255.255.255 (where x is a number from 0 to 255)</p> <p>Subnet Mask: You can input the subnet mask for the projector.*¹ You can enter a number from 0 to 255 in each field of the address. However, the following subnet masks cannot be used. 0.0.0.0, 255.255.255.255</p> <p>Gateway Address: You can input the IP address for the gateway for the projector.*¹ You can enter a number from 0 to 255 in each field of the address. However, the following gateway addresses cannot be used. 0.0.0.0, 127.x.x.x, 224.0.0.0 to 255.255.255.255 (where x is a number from 0 to 255)</p> <p>MAC Address: You can display the MAC address for the projector.</p> |
| PJLink Password | <p>Enter a password to use when you access the projector using compatible PJLink software.*¹  p.115</p> <p>You can enter up to 32 single-byte alphanumeric characters.</p> |
| Web Control Password | <p>Enter a password to use when making settings and controlling the projector using Web control.*¹ You can enter up to 8 single-byte alphanumeric characters.</p> <p>Web control is a computer function that allows you to set up and control the projector by using the Web browser on a computer running EMP Monitor.  EMP Monitor Operation Guide</p> |

| Sub Menu | Function |
|--------------------------------|--|
| <u>SNMP</u> ▶▶ | You can make SNMP settings. Trap IP Address 1/Trap IP Address 2: You can register up to two as the SNMP trap notification destination.*1 To use SNMP to monitor the projector, you need to install the SNMP manager program on your computer. SNMP should be managed by a network expert. |
| Mail | When this is set, you receive an e-mail notification if a problem or warning occurs in the projector. For information on the contents of the sent e-mail, see "Reading Problem Mail Notification Function" p.111 Mail Notification function: You can set whether or not (On/Off) to be notified by e-mail. If this is set to "Off" you cannot set any more addresses. SMTP Server: You can input the IP address for the SMTP server for the projector.*1 You can enter a number from 0 to 255 in each field of the address. However, the following IP addresses cannot be used. 127.x.x.x, 224.0.0.0 to 255.255.255.255 (where x is a number from 0 to 255) Port Number: You can display the SMTP server's port number. The default value is 25. When editing settings from WEB control, you can change the port number by entering a valid number from 1 to 65535. Address 1 Setting/Address 2 Setting/Address 3 Setting: You can enter the e-mail address*1 and the contents of the message to receive notification when a problem or warning occurs. You can register up to three destinations. You can enter up to 32 single-byte alphanumeric characters for the e-mail addresses. |
| <u>AMX Device Discovery</u> ▶▶ | When the projector is connected to a network, set this to "On" to allow the projector to be detected by AMX Device Discovery. Set this to "Off" if you are not connected to an environment controlled with a controller from AMX or AMX Device Discovery. |
| Projector name | Displays the projector name used to identify the projector when connected to a network. |
| Reset | You can reset all adjustment values for the "Network" menu to their default settings. To return all menu items to their default settings, see p.64 |

*1 When inputting numbers and passwords, the following software keyboards are displayed. Tilt the [⊙] button on the remote control to move the cursor to the target key, and then press the [Enter] button. Enter figures by holding down the [Num] button on the remote control, and pressing the numeric buttons. After inputting, press [Finish] on the keyboard to confirm your input. Press [Cancel] on the keyboard to cancel your input.

Each time this key is selected, it sets and changes between upper case and lower case letters.

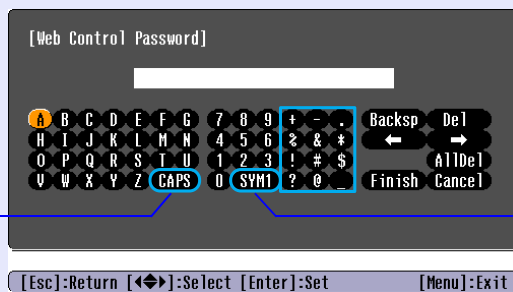

Each time this key is selected, it sets and changes the symbol keys for the section enclosed by the frame.

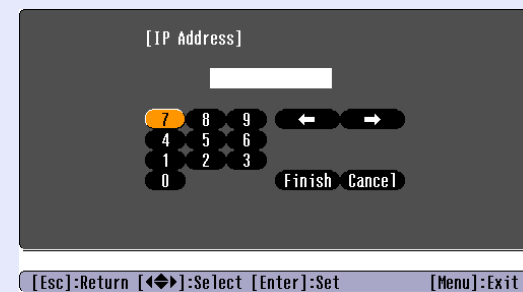

Network Menu (EB-G5350/G5150 only)

When "Network Protect" is set to "On" in "Password Protect", a message is displayed and the settings cannot be changed. You can make changes after setting "Network Protect" to "Off".  [p.34](#)

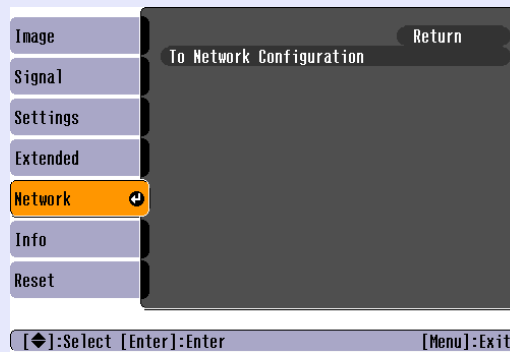

| Sub Menu | Function |
|--------------------------|---|
| To Network Configuration | The following menus are available for setting network items. "Basic", "Wireless LAN", "Security", "Wired LAN", "Mail", "Others", "Reset" and "Setup complete". |



By using the Web browser of a computer connected to the projector on a network, you can set the projector's functions and control the projector. This function is called "Web control". You can easily enter text using a keyboard to make settings for Web control such as security settings.  [EasyMP Operation Guide "Changing Settings Using a Web Browser \(Web Control\)"](#)

■ Notes on operating the network menu

Selecting from the top menu and sub menus, and changing of selected items are the same as operations in the configuration menu.

When done, make sure you go to the "Complete menu", and select one of "Yes", "No", or "Cancel". When you select "Yes" or "No", you return to the configuration menu.

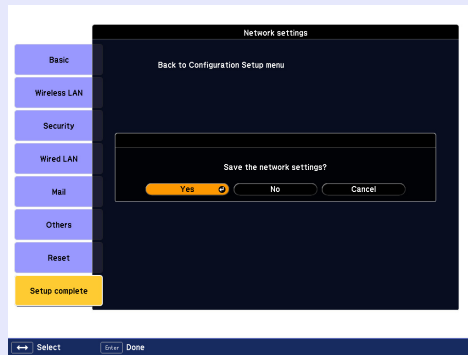

- Yes:** Saves the settings and exits the network menu.
- No:** Exits to the network menu without saving the settings.
- Cancel:** Continues displaying the network menu.

■ Soft keyboard operations

The network menu contains items that require input of alphanumerics during setup. In this case, the following software keyboard is displayed. Use the [⊙] button on the remote control or [↖/▲], [↘/▼], [↙/◀], and [↗/▶] on the projector to move the cursor to the desired key, and then press the [Enter] button to enter the alphanumeric. Enter figures by holding down the [Num] button on the remote control, and pressing the numeric buttons. After inputting, press [Finish] on the keyboard to confirm your input. Press [Cancel] on the keyboard to cancel your input.





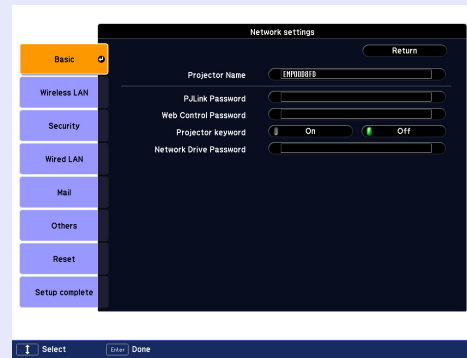

Each time this key is selected, it sets and changes between upper case and lower case letters.

Each time this key is selected, it sets and changes the symbol keys for the section enclosed by the frame.

Basic Menu



| Sub Menu | Function |
|------------------------|---|
| Projector name | Displays the projector name used to identify the projector when connected to a network. The default value is "EBxxxxxx" (where xxxxxx are the last six digits of the MAC Address). When editing, you can enter up to 16 single-byte alphanumeric characters. |
| PJLink Password | Set a password to use when you access the projector using compatible PJLink software.  p.115 You can enter up to 32 single-byte alphanumeric characters. |
| Web Control Password | Set a password to use when making settings and controlling the projector using Web control.*You can enter up to 8 single-byte alphanumeric characters. Web control is a computer function that allows you to set up and control the projector by using the Web browser on a computer connected on a network.  EasyMP Operation Guide "Changing Settings Using a Web Browser (Web Control)" |
| Projector Keyword | When set to "On", you have to enter the keyword when you try to connect the projector to a computer on a network. As a result, you can prevent presentations from being interrupted by unscheduled connections from the computer. Normally this should be set to "ON".  EasyMP Operation Guide "Connecting to a Projector on a Network and Projecting" |
| Network drive password | To prevent third parties from overwriting/deleting a file on the SD card without permission, you can set a password. You can enter up to 16 single-byte alphanumeric characters.  EasyMP Operation Guide "Copying or Deleting SD Card Files over the Network" |

■ Wireless LAN menu (only when the optional wireless LAN unit is installed)



| Sub Menu | Function |
|--------------------------|--|
| Connection mode | When the projector is connected to a computer with EMP NS Connection, set so that it is in a permanently connected mode. |
| Setup by WPS | When using a WPS (Wi-Fi Protected Setup) compatible access point via a wireless LAN, you can easily connect the projector to the access point and make security settings.  p.95 |
| Antenna level | Displays the wireless LAN wave strength. |
| Wireless LAN system | Sets the wireless LAN system. |
| <u>SSID</u> » | Enter an SSID. When an SSID is provided for the wireless LAN system in which the projector participates, enter the SSID. The default value is EPSON. You can enter up to 32 single-byte alphanumeric characters. |
| <u>DHCP</u> » | You can set whether or not (On/Off) to use DHCP. If this is set to "On" you cannot set any more addresses. |
| <u>IP Address</u> » | You can input the IP address assigned to the projector. You can input a number from 0 to 255 in each field of the address. However, the following IP addresses cannot be used. 0.0.0.0, 127.x.x.x, 224.0.0.0 to 255.255.255.255 (where x is a number from 0 to 255) |
| <u>Subnet Mask</u> » | You can input the subnet mask for the projector. You can input a number from 0 to 255 in each field of the address. However, the following subnet masks cannot be used. 0.0.0.0, 255.255.255.255 |
| <u>Gateway Address</u> » | You can input the IP address for the gateway for the projector. You can input a number from 0 to 255 in each field of the address. However, the following gateway addresses cannot be used. 0.0.0.0, 127.x.x.x, 224.0.0.0 to 255.255.255.255 (where x is a number from 0 to 255) |



| Sub Menu | Function |
|--------------------|---|
| MAC Address | Displays the MAC address. |
| SSID Display | To prevent the SSID from being displayed on the EasyMP Standby screen, set this to Off. |
| IP Address Display | To prevent the IP address from being displayed on the EasyMP Standby screen, set this to Off. |

■ Security menu (Only available when the optional wireless LAN unit is installed)

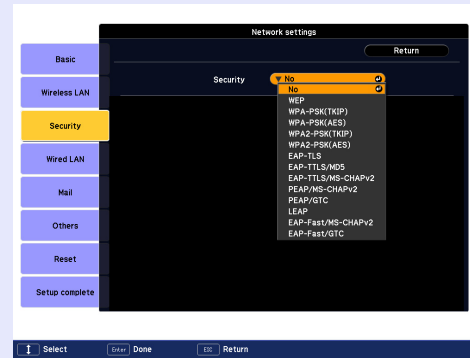

| Sub Menu | Function |
|----------|--|
| Security | Select the security type from the items that are displayed. When setting up security, follow the instructions from the administrator of the network system you are about to access. |

Type of security

When the optional wireless LAN unit is installed and being used in Manual Mode, it is strongly recommended that you set security. Select one of the following security methods.

- WEP
 - Data is encrypted with a code key (WEP key)
 - This mechanism prevents communication unless the encrypted keys for the access point and the projector match.
- WPA/WPA2
 - This is an encryption standard that improves security which is a weak point of WEP. Although there are multiple kinds of WPA encryption methods, this projector uses "TKIP". TKIP uses PSK (Pre-Shared Key) to automatically update the encryption key at regular fixed intervals, which makes it harder to break compared to WEP which uses a constant encryption key.
 - WPA also includes user authentication functions. WPA authentication provides two methods: using an authentication server, or authenticating between a computer and an access point without a server. This projector supports the latter method, without a server.
- EAP
 - EAP is a protocol used for communication between clients and authentication servers. These are multiple protocols, such as EAP-TLS which uses electronic certification for user authentication, LEAP which uses user ID and password, and EAP-TTLS.

| System | Authentication |
|----------------|--|
| EAP-TLS | Electronic certification, CA certification |
| EAP-TTLS | User ID, Password |
| PEAP/MS-CHAPv2 | User ID, Password |
| PEAP/EAP-GTC | User ID, Password |
| LEAP | User ID, Password |



- *For setting details, follow the directions from the network administrator of your network.*
- *If using EAP, you need to make settings at the projector that match the authentication server settings. Check with your network administrator for details on RADIUS settings.*
- *Register an electronic certificate and a CA certificate to the projector. Only one set of an electronic certificate and a CA certificate can be registered to the projector. These certificates are used with EAP-TLS.*



■ When WEP is selected

| Sub Menu | Function |
|---|---|
| WEP encryption | You can set the encryption for WEP encoding. 128 bit: Uses 128 (104) bit encoding 64 bit: Uses 64 (40) bit encoding |
| Format | You can set the input method for the WEP encrypted key. ASCII: Input text. The method of inputting the encrypted WEP with text differs depending on the access point. Check with the network administrator for the network in which the projector participates, and then set to "ASCII". HEX: Input in hexadecimal. |
| Key ID | Selects the WEP encryption ID key. |
| Encrypted key 1/ Encrypted key 2/ Encrypted key 3/ Encrypted key 4 | You can enter the key used for WEP encryption. Enter the key in single-byte characters following instructions from the network administrator for the network in which the projector participates. The type of character and the number that can be entered differ according to the "WEP Encryption" and "Format" settings. If the number of characters you enter is shorter than the required character length, no character is encrypted. If the number of characters you enter is longer than the required character length, characters that exceed the permitted number are not encrypted. "128 bit" - "ASCII": Single-byte alphanumerics, 13 characters. "64 bit" - "ASCII": Single-byte alphanumerics, 5 characters. "128 bit" - "HEX": 0 to 9 and A to F, 26 characters "64 bit" - "HEX": 0 to 9 and A to F, 10 characters |

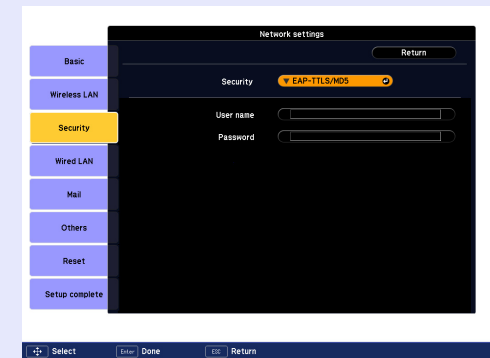
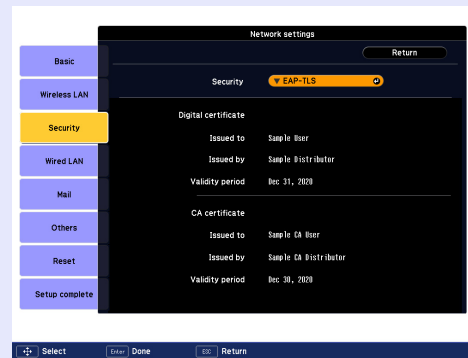
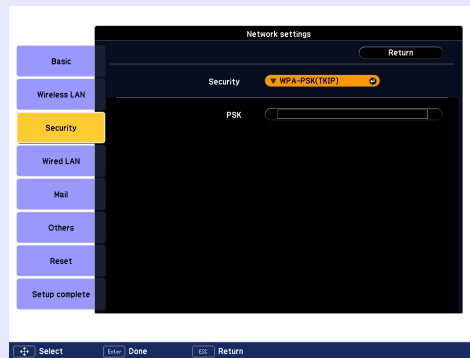

■ When WPA-PSK (TKIP) or WPA2-PSK (AES) are selected

| Sub Menu | Function |
|----------------------|--|
| PSK (Encryption key) | You can enter a Pre-Shared Key (encrypted key) in single-byte alphanumeric characters. Enter at least 8 and up to 63 characters. When the Pre-Shared Key is entered and the [Enter] button is pressed, the value is set and displayed as an asterisk (*). You cannot enter more than 32 characters on the configuration menu. When setting from Web Control, you can enter more than 32 characters. EasyMP Operation Guide "Changing Settings Using a Web Browser (Web Control)" |

■ When EAP-TLS is selected

| Sub Menu | Function |
|-------------------------------------|--|
| Issued to/Issued by/Validity period | Information in the certificate is displayed. You cannot enter. |

■ When EAP-TTLS/MD5, EAP-TTLS/MS-CHAPv2, PEAP/MS-CHAPv2, PEAP/GTC, LEAP, EAP-Fast/MS-CHAPv2 or EAP-FAST/GTC are selected

| Sub Menu | Function |
|-----------|---|
| User name | You can enter a user name to be used for authentication in single-byte alphanumeric characters (no spaces). You can enter up to 64 characters. You cannot enter more than 32 characters on the configuration menu. When setting from Web Control, you can enter more than 32 characters. EasyMP Operation Guide "Changing Settings Using a Web Browser (Web Control)" |
| Password | You can enter an authentication password in single-byte alphanumeric characters. You can enter up to 64 characters. When the password is entered and the [Enter] button is pressed, the value is set and displayed as an asterisk (*). You cannot enter more than 32 characters on the configuration menu. When setting from Web Control, you can enter more than 32 characters. EasyMP Operation Guide "Changing Settings Using a Web Browser (Web Control)" |

■ Wired LAN Menu



| Sub Menu | Function |
|--------------------------|--|
| <u>DHCP</u> » | You can set whether or not (On/Off) to use DHCP. If this is set to "On" you cannot set any more addresses. |
| <u>IP Address</u> » | You can input the IP address assigned to the projector. You can input a number from 0 to 255 in each field of the address. However, the following IP addresses cannot be used. 0.0.0.0, 127.x.x.x, 224.0.0.0 to 255.255.255.255 (where x is a number from 0 to 255) |
| <u>Subnet Mask</u> » | You can input the subnet mask for the projector. You can input a number from 0 to 255 in each field of the address. However, the following subnet masks cannot be used. 0.0.0.0, 255.255.255.255 |
| <u>Gateway Address</u> » | You can input the IP address for the gateway for the projector. You can input a number from 0 to 255 in each field of the address. However, the following gateway addresses cannot be used. 0.0.0.0, 127.x.x.x, 224.0.0.0 to 255.255.255.255 (where x is a number from 0 to 255) |
| MAC Address | Displays the MAC address. |
| IP Address Display | To prevent the IP address from being displayed on the EasyMP Standby screen, set this to Off. |

■ Mail menu

When this is set, you receive an e-mail notification if a problem or warning occurs in the projector. For information on the contents of the sent e-mail,  "Reading Problem Mail Notification Function" [p.111](#)

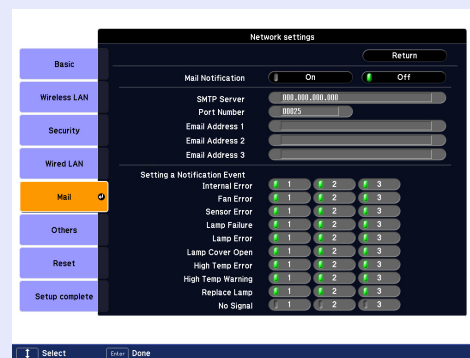

| Sub Menu | Function |
|---|--|
| Mail Notification function | You can set whether or not (On/Off) to be notified by e-mail. |
| SMTP server | You can input the <u>IP address</u> for the SMTP server for the projector. You can input a number from 0 to 255 in each field of the address. However, the following IP addresses cannot be used. 127.x.x.x, 224.0.0.0 to 255.255.255.255 (where x is a number from 0 to 255) |
| Port Number | You can input the port number for the SMTP server. The default value is 25 You can input numbers between 1 to 65535. |
| Email Address 1/ Email Address 2/ Email Address 3 | You can input the e-mail address of the destination to send the notification e-mail to. You can register up to three destinations. You can enter up to 32 single-byte alphanumeric characters for the e-mail addresses. |
| Setting a Notification Event | You can select the problems or warnings to be notified about by e-mail. When the selected problem or warning occurs in the projector, an e-mail is sent to the specified "Destination address" notifying that a problem or warning has occurred. You can select multiple items from the displayed items. |

■ Others menu

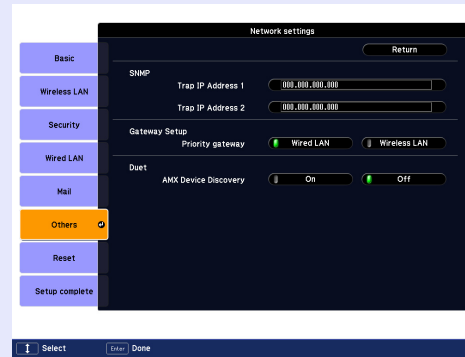

| Sub Menu | Function |
|---|---|
| <u>SNMP trap IP address</u> 1/ SNMP trap IP address 2 | <p>You can register up to two for the <u>SNMP</u> trap notification destination.</p> <p>You can input a number from 0 to 255 in each field of the address.</p> <p>However, the following IP addresses cannot be used.</p> <p>127.x.x.x, 224.0.0.0 to 255.255.255.255 (where x is a number from 0 to 255)</p> <p>To use SNMP to monitor the projector, you need to install the SNMP manager program on your computer. SNMP should be managed by a network administrator.</p> |
| <u>Gateway Setting</u> | For the priority gateway, select either wireless or wired. |
| <u>AMX Device Discovery</u> | When the projector is connected to a network, set this to "On" to allow the projector to be detected by AMX Device Discovery. Set this to "Off" if you are not connected to an environment controlled with a controller from AMX or AMX Device Discovery. |

■ Reset Menu

Resets all of the network settings.

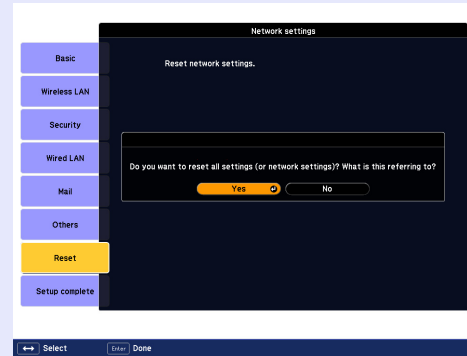

| Sub Menu | Function |
|-----------------------------|--|
| Reset all network settings. | To reset all of the network settings, select Yes. After you reset all the settings, the Basic menu appears. |

Info Menu (Display Only)

Lets you check the status of the image signals being projected and the status of the projector. Items displayed vary depending on the image signal currently being projected as shown in the following screen shots.

Computer image/Component video▶/ When the signal status is input from the HDMI input port

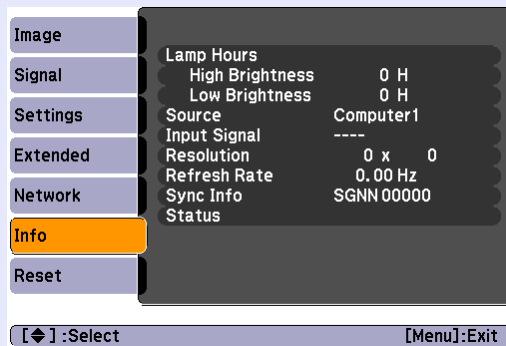

Composite video▶/S-video▶

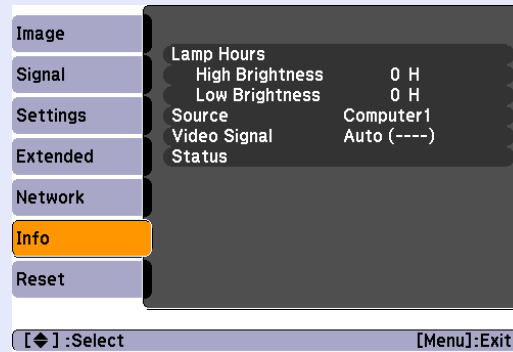

EasyMP(EB-G5350/G5150 only)

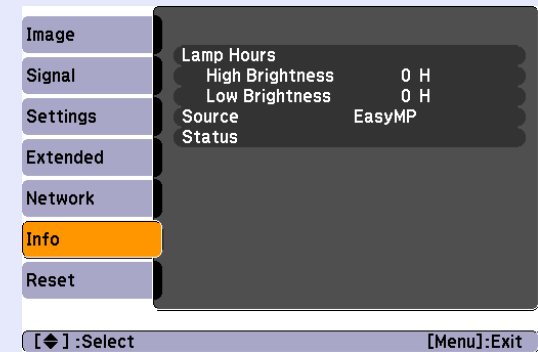

| Sub Menu | Function |
|-----------------------|--|
| Lamp hours | You can display the cumulative lamp operating time*. When it reaches the lamp warning time, the characters are displayed in yellow. |
| Source | You can display the input port name for the connected equipment currently being projected. |
| Input signal | You can display the content of "Input Signal" set in the "Signal" menu according to the "Source". |
| Resolution | You can display the input resolution. |
| Video signal | You can display the content of "Video Signal" set in the "Signal" menu. |
| <u>Refresh Rate</u> ▶ | You can display the refresh rate. |
| <u>Sync</u> ▶ Info | You can display the image signal information. This information may be needed if service is required. |
| Status | This is information about errors that have occurred on the projector. This information may be needed if service is required. |

* The cumulative use time is displayed as "0H" for the first 10 hours. * 10 hours and above is displayed as "10H", "11H", and so on.

Reset Menu

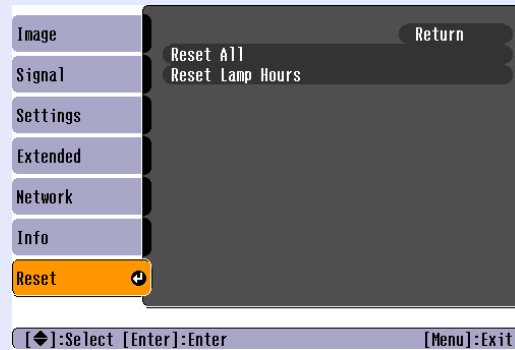

| Sub Menu | Function |
|------------------|---|
| Reset all | You can reset all items in all menus to their default settings. The following items are not reset to their defaults: "Input Signal", "User's Logo", "Multi-screen", all items for "Network" menus, "Lamp Hours", and "Language". |
| Reset Lamp Hours | You can clear the cumulative lamp hours use time, and return it to "0H". Reset when you replace the lamp. |



Troubleshooting

This chapter describes how to identify problems and what to do if a problem is found.

| | |
|--|-----------|
| Using the Help..... | 66 |
| Problem Solving | 67 |
| • Reading the Indicators..... | 67 |
| [⏻] Power indicator lights red | 68 |
| 🔴 ⚠ Indicator is lit or flashing orange..... | 69 |
| • When the Indicators Provide No Help | 70 |
| Problems relating to images | 71 |
| Problems when projection starts..... | 75 |
| Other problems | 76 |

If a problem occurs with the projector, Help uses on-screen displays to assist you in solving the problem. You can solve problems by answering the questions.

Procedure

1 Press the [Help] button.

The help screen is displayed.

Using the remote control

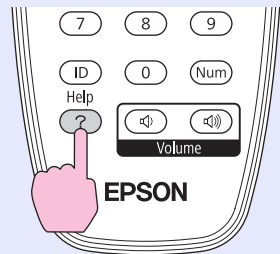

Using the control panel

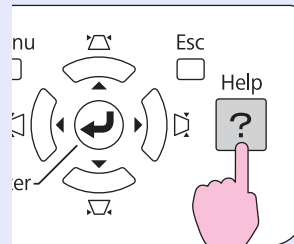

2 Select a menu item.

[Help]

The image is small. ◀

The image is projected as a trapezoid.
The color tone is unusual.
There is no audio or it is too low.

[◀]:Select [Enter]:Enter [Help]:Exit

Using the remote control

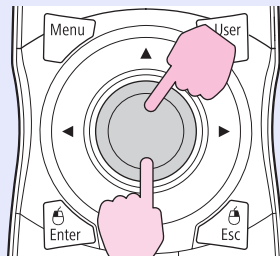

Using the control panel

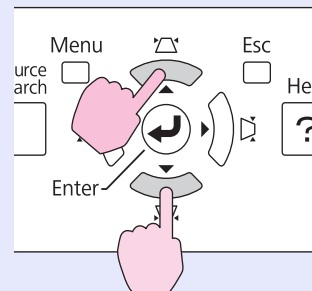

3

Confirm the selection.

Using the remote control

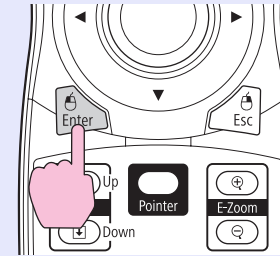

Using the control panel

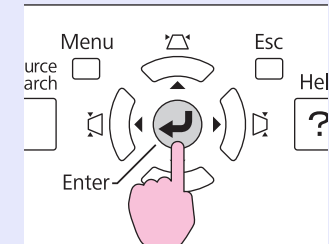

Questions and solutions are displayed as shown on the screen below.

Press the [Help] button to exit Help.

The image is small.

- Is zoom set to minimum?
-Use the zoom ring to change the size of the image.
- Is the projector too close to the screen?
-Move the projector away from the screen.

[Esc]:Return

[Help]:Exit



If Help does not provide a solution to the problem, refer to "Problem Solving" (p.67).

If you are having a problem with the projector, first check the projector's indicators and refer to "Reading the Indicators" below.
If the indicators do not show clearly what the problem might be, refer to "When the Indicators Provide No Help".  p.70

Reading the Indicators

The projector is provided with the following three indicators that indicate the operating status of the projector.

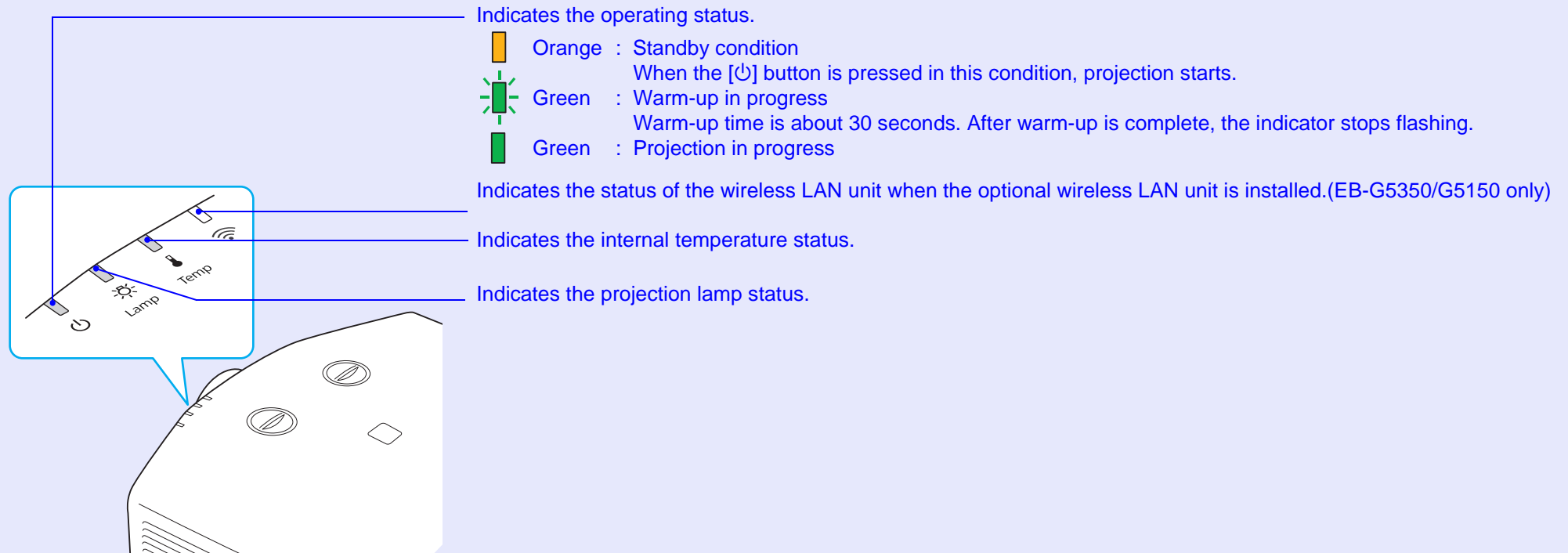

Refer to the following table to see what the indicators mean and how to remedy problems that they indicate.

If all indicators are off, check that the power cable is connected correctly and that the power is being supplied normally.

Sometimes, when the power cable is unplugged, the [⏻] indicator remains lit for a short period, this is not a fault.

■ [⏻] Power indicator lights red **Abnormal**

■ : Lit ■ : Flashing: □ : Off

| Status | Cause | Remedy or Status |
|--------------------|---|---|
| <p>Red Red Red</p> | Internal Error | Stop using the projector, disconnect the power cable from the electrical outlet, and contact your local dealer or the nearest address provided in the Support and Service Guide. Epson Projector Contact List |
| <p>Red □ Red</p> | Fan Error Sensor Error | Stop using the projector, disconnect the power cable from the electrical outlet, and contact your local dealer or the nearest address provided in the Support and Service Guide. Epson Projector Contact List |
| <p>Red □ Red</p> | High Temp Error (overheating) | <p>The lamp turns off automatically and projection stops. Wait for about five minutes. After about five minutes the projector switches to standby mode, so check the following two points.</p> <ul style="list-style-type: none"> • Check that the air filter and air exhaust vent are clear, and that the projector is not positioned against a wall. • If the air filter is clogged, clean or replace it. p.81, 88 <p>If the error continues after checking the points above, stop using the projector, disconnect the power cable from the electrical outlet, and contact your local dealer or the nearest address provided in the Support and Service Guide. Epson Projector Contact List</p> <p>When using at an altitude of 1500 m or more, set "High Altitude Mode" to "On". p.47</p> |
| <p>Red Red □</p> | Lamp Error Lamp Failure Lamp Cover Open | <p>Check the following two points.</p> <ul style="list-style-type: none"> • Take out the lamp and check if it is cracked. p.85 • Clean the air filter. p.81 <p>If it is not cracked → Re-fit the lamp and turn on the power. If the error continues → Replace the lamp with a new lamp and turn on the power. If the error continues → Stop using the projector, disconnect the power cable from the electrical outlet, and contact your local dealer or the nearest address provided in the Support and Service Guide. Epson Projector Contact List</p> <p>If it is cracked → Replace it with a new lamp, or contact your local dealer for further advice. If replacing the lamp yourself, be careful to avoid pieces of broken glass (you cannot continue projecting until the lamp is replaced). Epson Projector Contact List</p> <p>Check that the lamp cover and the lamp are securely installed. p.85 If the lamp cover or the lamp is not securely installed, the lamp does not switch on.</p> <p>When using at an altitude of 1500 m or more, set "High Altitude Mode" to "On". p.47</p> |

■ Indicator is lit or flashing orange **Warning**

: Lit : Flashing : Off : Varies according to the projector status

| Status | Cause | Remedy or Status |
|--------------------------------|-------------------|---|
| <p>Red Orange </p> <p> </p> | High Temp Warning | <p>(This is not an abnormality. However, if the temperature rises too high again, projection stops automatically.)</p> <ul style="list-style-type: none"> • Check that the air filter and air exhaust vent are clear, and that the projector is not positioned against a wall. • If the air filter is clogged, clean or replace it. p.81, 88 |
| <p>Orange </p> <p> </p> | Replace Lamp | <p>Replace it with a new lamp. p.85</p> <p>If you continue to use the lamp after the replacement period has passed, the possibility that the lamp may explode increases. Replace it with a new lamp as soon as possible.</p> |













- *If the projector is not operating properly, even though the indicators are all showing normal, refer to "When the Indicators Provide No Help" ([p.70](#)).*
- *If the error is not indicated in this table, stop using the projector, disconnect the power cable from the electrical outlet, and contact your local dealer or the nearest address provided in the Support and Service Guide. [Epson Projector Contact List](#)*

When the Indicators Provide No Help

If any of the following problems occur and the indicators do not offer a solution, refer to the pages given for each problem.





Problems relating to images

- **No images appear**  [p.71](#)
Projection does not start, the projection area is completely black, the projection area is completely blue, and so on.
- **Moving images are not displayed**  [p.71](#)
Moving images being projected from a computer appear black and nothing is projected.
- **Projection stops automatically**  [p.71](#)
- **The message "Not supported." is displayed.**  [p.72](#)
- **The message "No Signal." is displayed.**  [p.72](#)
- **Images are fuzzy or out of focus**  [p.72](#)
- **Interference or distortion appear in images**  [p.73](#)
Problems such as interference, distortion, or black & white checked patterns appear.
- **The image is truncated (large) or small, or the aspect is not suitable**  [p.73](#)
Only part of the image is displayed, or the height and width ratios of the image are not correct, and so on.
- **Image colors are not right**  [p.74](#)
The whole image appears purplish or greenish, images are black & white, colors appear dull, and so on.
(Computer monitors and LCD screens have different color reproduction performance, so that the colors projected by the projector and the colors appearing on the monitor may not necessarily match, but this is not a sign of a problem.)
- **Images appear dark**  [p.74](#)
- **Nothing appears on the external monitor**  [p.75](#)

Problems when projection starts

- **Power does not turn on**  [p.75](#)

Other problems

- **No sound can be heard or the sound is faint**  [p.76](#)
- **The remote control does not work**  [p.76](#)
- **I want to change the language for messages and menus**  [p.76](#)
- **E-mail is not received even if a problem occurs in the projector**  [p.77](#)

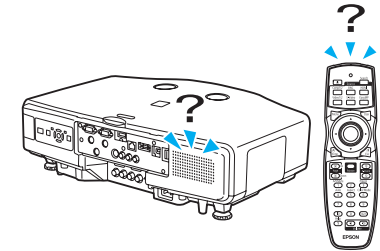

■ **Problems relating to images**

■ **No images appear**

| Check | Remedy |
|---|---|
| Did you press the [⏻] button? | Press the [⏻] button to turn the power on. |
| Are the indicators switched off? | The power cable is not connected correctly or power is not being supplied normally. Connect the projector's power cable correctly. 🖱️ <i>Quick Start Guide</i> Check that your electrical outlet or power source is functioning correctly. |
| Is A/V Mute active? | Press the [A/V Mute] button on the remote control to cancel A/V Mute. 🖱️ p.22 |
| Are the configuration menu settings correct? | Reset all of the settings. 🖱️ "Reset" - "Reset All" p.64 |
| Is the projected image completely black? Only when projecting computer images | Some input images, such as screen savers, may be completely black. |
| Is the image signal format setting correct? Only when projecting images from a video source | Change the setting according to the signal for the connected equipment. 🖱️ "Signal" - "Video Signal" p.43 |

■ **Moving images are not displayed**

| Check | Remedy |
|---|--|
| Is the computer's image signal being output to the LCD and the monitor? Only when projecting images from a laptop computer or a computer with a built-in LCD screen | Change the image signal to external output only. 🖱️ Check your computer's documentation. |

■ **Projection stops automatically**

| Check | Remedy |
|------------------------------|---|
| Is "Sleep Mode" set to "On"? | Press the [⏻] button to turn the power on. If you do not want to use "Sleep Mode", change the setting to "Off". 🖱️ "Extended" - "Operation" - "Sleep Mode" p.47 |

■ The message "Not supported." is displayed.

| Check | Remedy |
|--|--|
| Is the image signal format setting correct? Only when projecting images from a video source | Change the setting according to the signal for the connected equipment. 🖱️ "Signal" - "Video Signal" p.43 |
| Do the image signal resolution and the refresh rate correspond to the mode? Only when projecting computer images | Refer to the computer's documentation for how to change the image signal resolution and the refresh rate output from the computer. 🖱️ "List of Supported Monitor Displays" p.116 |

■ The message "No Signal." is displayed.

| Check | Remedy |
|--|--|
| Are the cables connected correctly? | Check that all the cables required for projection are securely connected. 🖱️ <i>Quick Start Guide</i> |
| Is the correct input port selected? | Change the image by pressing the [Source Search] button on the remote control or the control panel. 🖱️ p.19 |
| Is the power for the computer or video source turned on? | Turn the power on for the equipment. |
| Are the image signals being output to the projector? Only when projecting images from a laptop computer or a computer with a built-in LCD screen | If the image signals are only being output to the computer's LCD monitor or to the accessory monitor, you need to change the output to an external destination as well as the computer's own monitor. For some computer models, when the image signals are output externally, they no longer appear on the LCD monitor or accessory monitor. 🖱️ Computer's documentation, under a title such as "External output" or "Connecting an external monitor". If the connection is made while the power of the projector or computer is already turned on, the function [Fn] key that changes the computer's image signal to external output may not work. Turn the power for the computer and the projector off and then back on again. |

■ Images are fuzzy or out of focus

| Check | Remedy |
|---|---|
| Is the focus adjusted correctly? | Turn the focus ring to adjust the focus. 🖱️ <i>Quick Start Guide</i> |
| Is the projector at the correct distance? | Is it projecting outside of the recommended projection distance range? Setup within the recommended range. 🖱️ p.99 |
| Is the Keystone adjustment value too large? | Lower the projection angle to reduce the amount of keystone correction. 🖱️ <i>Quick Start Guide</i> |

| Check | Remedy |
|--------------------------------------|---|
| Has condensation formed on the lens? | If the projector is suddenly taken from a cold environment to a warm environment, or if sudden ambient temperature changes occur, condensation may form on the surface of the lens, and this may cause the images to appear fuzzy. Set the projector up in the room about one hour before it is used. If condensation forms on the lens, turn the projector off and wait for the condensation to disappear. |

■ Interference or distortion appear in images

| Check | Remedy |
|--|--|
| Is the image signal format setting correct? Only when projecting images from a video source | Change the setting according to the signal for the connected equipment. 🖱️ "Signal" - "Video Signal" p.43 |
| Are the cables connected correctly? | Check that all the cables required for projection are securely connected. 🖱️ <i>Quick Start Guide</i> |
| Is an extension cable being used? | If an extension cable is used, electrical interference may affect the signals. Use the cables supplied with the projector to check if the cables you are using may be causing the problem. |
| Is the correct resolution selected? Only when projecting computer images | Set the computer so that the signals being output are compatible with the projector. 🖱️ "List of Supported Monitor Displays" p.116 🖱️ Computer documentation |
| Are the "Sync.▶▶" and "Tracking▶▶" settings adjusted correctly? Only when projecting computer images | Press the [Auto] button on the remote control or the [Enter] button on the control panel to perform automatic adjustment. If the images are not adjusted correctly after using automatic adjustment, you can make the adjustments using "Sync." and "Tracking" from the configuration menu. 🖱️ "Signal" - "Tracking", "Sync." p.42 |

■ The image is truncated (large) or small, or the aspect is not suitable

| Check | Remedy |
|--|---|
| Is a wide panel computer image being projected? Only when projecting computer images | Change the setting according to the signal for the connected equipment. 🖱️ "Signal" - "Resolution" p.42 |
| Is the image still being enlarged by E-Zoom? | Press the [Esc] button on the remote control to cancel E-Zoom. 🖱️ p.28 |
| Is "Position" adjusted correctly? | Press the [Auto] button on the remote control or the [Enter] button on the control panel to perform automatic adjustment of the computer image being projected. If the images are not adjusted correctly after using automatic adjustment, you can make the adjustments using "Position" from the configuration menu. Apart from computer image signals, you can adjust other signals while projecting by adjusting "Position" from the configuration menu. 🖱️ "Signal" - "Position" p.42 |

| Check | Remedy |
|--|---|
| Is the computer set for dual display? Only when projecting computer images | If dual display is activated in the "Display Properties" of the computer's control panel, only about half of the image on the computer screen is projected. To display the entire image on the computer screen, turn off the dual display setting. 🖱️ Computer video driver documentation |
| Is the correct resolution selected? Only when projecting computer images | Set the computer so that the signals being output are compatible with the projector. 🖱️ "List of Supported Monitor Displays" p.116 🖱️ Computer documentation |

■ Image colors are not right

| Check | Remedy |
|---|--|
| Do the input signal settings match the signals from the connected device? | Change the following settings according to the signal for the connected equipment. When projecting images from equipment connected to Computer1/2 input port or BNC input port 🖱️ "Signal" - "Input Signal" p.43 When projecting images from equipment connected to Video1/2 or S-Video 🖱️ "Signal" - "Video Signal" p.43 |
| Is the image brightness adjusted correctly? | Adjust the "Brightness" setting from the configuration menu. 🖱️ "Image" - "Brightness" p.41 |
| Are the cables connected correctly? | Check that all the cables required for projection are securely connected. 🖱️ <i>Quick Start Guide</i> |
| Is the " <u>contrast</u> ▶▶" setting adjusted correctly? | Adjust the "Contrast" setting from the configuration menu. 🖱️ "Image" - "Contrast" p.41 |
| Is the color adjusted correctly? | Adjust the "Color Adjustment" setting from the configuration menu. 🖱️ "Image" - "Color Adjustment" p.41 |
| Are the color saturation and tint adjusted correctly? Only when projecting images from a video source | Adjust the "Color Saturation" and "Tint" settings from the configuration menu. 🖱️ "Image" - "Color Saturation", "Tint" p.41 |

■ Images appear dark





| Check | Remedy |
|--|--|
| Are the image brightness and luminance adjusted correctly? | Adjust the "Brightness" and "Brightness Control" settings from the configuration menu. 🖱️ "Image" - "Brightness" p.41 🖱️ "Settings" - "Brightness Control" p.44 |
| Is the " <u>contrast</u> ▶▶" setting adjusted correctly? | Adjust the "Contrast" setting from the configuration menu. 🖱️ "Image" - "Contrast" p.41 |
| Is the lamp due for replacement? | When the lamp is nearly ready for replacement, the images become darker and the color quality becomes poorer. When this happens, replace the lamp with a new lamp. 🖱️ p.85 |

■ Nothing appears on the external monitor

| Check | Remedy |
|---|---|
| Are images from a port other than the Computer1/2 or BNC input ports being projected? | The only images that can be displayed on an external monitor are computer images from Computer1/2 or BNC input ports.  p.101 |



■ Problems when projection starts

■ Power does not turn on







| Check | Remedy |
|---|---|
| Did you press the [⏻] button? | Press the ⏻ button to turn the power on. |
| Are the indicators switched off? | The power cable is not connected correctly or power is not being supplied normally. Disconnect and then reconnect the power cable.  Quick Start Guide Check that your electrical outlet or power source is functioning correctly. |
| Do the indicators turn on and off when the power cable is touched? | There is probably a poor contact in the power cable, or the power cable may be defective. Reinsert the power cable. If this does not solve the problem, stop using the projector, disconnect the power cable from the electrical outlet, and contact your local dealer or the nearest address provided in the Support and Service Guide.  Epson Projector Contact List |
| Is the Control Panel Lock set to "Full Lock"? | Press the [⏻] button on the remote control. If you do not want to use "Control Panel Lock", change the setting to "Off".  "Settings" - "Control Panel Lock" p.36 |
| Is the correct setting for the remote receiver selected? | Check the "Remote Receiver" from the configuration menu.  "Settings" - "Remote receiver" p.44 |
| Was the power cable plugged back in immediately after Direct Power Off, or is the breaker turned off? | When the operation to the left is performed when "Direct Power On" is set to "On", the power may not turn back on. Press the [⏻] button to turn the power back on. |

■ Other problems

■ No sound can be heard or the sound is faint

| Check | Remedy |
|---|--|
| Is the audio source connected correctly? | Disconnect the cable from the audio input port, and then reconnect the cable. |
| Is the volume adjusted to the minimum setting? | Adjust the volume so that sound can be heard.  p.44 ,  Quick Start Guide |
| Is A/V Mute active? | Press the [A/V Mute] button on the remote control to cancel A/V Mute.  p.22 |
| Is the audio cable's specification "No resistance"? | When using a commercially available audio cable, make sure it is labeled "No resistance". |





■ The remote control does not work

| Check | Remedy |
|--|--|
| Is the remote control light-emitting area pointing towards the remote receiver on the projector when it is operated? | Point the remote control towards the remote receiver. Operating range  Quick Start Guide |
| Is the remote control too far from the projector? | The operating range for the remote control is about 10 m.  Quick Start Guide |
| Is direct sunlight or strong light from fluorescent lamps shining onto the remote receiver? | Set the projector up in a location where strong light does not shine onto the remote receiver. Or set the remote receiver to "Off" from "Remote Receiver" in the configuration menu.  "Settings" - "Remote receiver" p.44 |
| Is the correct setting for the remote receiver selected? | Check the "Remote Receiver" from the configuration menu.  "Settings" - "Remote receiver" p.44 |
| Are the remote control ID and the projector ID matched? | Make sure the ID for the projector you want to operate and the ID for the remote control match. To operate all projectors by remote control regardless of the ID setting, set the ID switch on the side of the remote control to Off.  p.29 |
| Are the batteries dead or have the batteries been inserted correctly? | Make sure the batteries are inserted correctly or replace the batteries with new ones if necessary.  p.84 |
| Is the optional remote control cable connected to the remote control or to the projector's remote port? | When the remote control cable is connected, the remote control light-emitting area or the projector's remote receiver are disabled. When not using the remote control cable set, disconnect it from the remote control and the remote port. |

■ I want to change the language for messages and menus

| Check | Remedy |
|--------------------------------|---|
| Change the "Language" setting. | Adjust the "Language" setting from the configuration menu.  p.47 |

■ E-mail is not received even if a problem occurs in the projector

| Check | Remedy |
|--|--|
| Is "Standby Mode" set to "Network On"? | To use the Mail Notification function when the projector is in standby, set "Network On" in "Standby Mode" from the configuration menu.  "Extended" - "Standby Mode" p.47 |
| Did a fatal abnormality occur and the projector come to a sudden stop? | When the projector comes to a sudden stop, e-mail cannot be sent. If the abnormal state continues, contact your local dealer or the nearest address provided in the Support and Service Guide.  Epson Projector Contact List |
| Is power being supplied to the projector? | Check that your electrical outlet or power source is functioning correctly. |
| Is the LAN cable connected correctly? | Check that the LAN cable is connected correctly. Reconnect it if it is not connected or it is not connected correctly.  p.107 |
| Is Mail Notification function set correctly in the configuration menu? | Mail Notification function of problems is sent according to the "Mail" settings in the configuration menu. Check if it is set correctly. For EB-G5350/G5150  "Network Menu" - "Mail Menu" p.60 For EB-G5300/G5200W/G5100  p.48 |



Appendices

This chapter provides information on maintenance procedures to ensure the best level of performance from the projector for a long time to come.

| | | | |
|---|-----------|---|------------|
| Installation Methods | 80 | Notes when packing and transporting..... | 92 |
| Cleaning..... | 81 | Saving a User's Logo..... | 93 |
| • Cleaning the Projector's Surface..... | 81 | Making a WPS (Wi-Fi Protected Setup) | |
| • Cleaning the Lens..... | 81 | Connection with a Wireless LAN Access Point | |
| • Cleaning the Air Filter..... | 81 | (EB-G5350/G5150 only) | 95 |
| Replacing Consumables | 84 | • Connection Setup Method | 95 |
| • Replacing the Remote Control Batteries | 84 | Making a Connection Using the Push Button Method | 96 |
| • Replacing the Lamp | 85 | Making a connection using the PIN Code Method..... | 97 |
| Lamp replacement period..... | 85 | Screen Size and Distance..... | 99 |
| How to replace the lamp..... | 85 | • Projection Distance for | |
| Resetting the lamp operating time..... | 87 | EB-G5350/G5300/G5150/G5100..... | 99 |
| • Replacing the Air Filter | 88 | • Projection Distance for EB-G5200W..... | 100 |
| Air filter replacement period | 88 | Connecting to External Equipment | 101 |
| How to replace the air filter..... | 88 | • Connecting to an External Monitor..... | 101 |
| Optional Accessories and Consumables | 90 | • Connecting to External Speakers..... | 101 |
| Optional accessories | 90 | Removing and Attaching the Projector Lens | |
| Consumables | 91 | Unit | 102 |
| Notes on Transportation | 92 | • Removing..... | 102 |
| • Moving Nearby..... | 92 | • Attaching | 102 |
| • When Transporting..... | 92 | | |
| Preparing packaging | 92 | | |



| | |
|--|------------|
| Connecting and Removing USB Devices (EB-G5350/G5150 only) | 104 |
| • Connecting USB Devices | 104 |
| • Reading the USB Indicators..... | 104 |
| • Removing USB Devices..... | 104 |
| Inserting and Ejecting SD Cards (EB-G5350/G5150 only) | 105 |
| • Inserting | 105 |
| • Reading the SD Card Access Lamp..... | 105 |
| • Removing | 106 |
| Connecting a LAN Cable | 107 |
| Connecting with a USB Cable and Projecting (USB Display EB-G5350/G5150 only)..... | 108 |
| • Connecting | 108 |
| Connecting for the first time | 109 |
| From the second time | 110 |
| Reading Problem Mail Notification Function | 111 |
| ESC/VP21 Commands | 112 |
| • Command List | 112 |
| • Cable Layouts | 113 |
| Serial connection | 113 |
| Communications protocol | 113 |

| | |
|--|------------|
| Regarding Network Projector (EB-G5350/G5150 only) | 114 |
| About PLink | 115 |
| List of Supported Monitor Displays | 116 |
| • Supported Monitor Displays for EB-G5350/G5300/G5150/G5100 | 116 |
| Computer signals (analog RGB)..... | 116 |
| Component Video | 117 |
| Composite video/S-video..... | 117 |
| Input signal from the HDMI input port..... | 118 |
| • Supported Monitor Displays for EB-G5200W | 119 |
| Computer signals (analog RGB)..... | 119 |
| Component Video | 120 |
| Composite video/S-video..... | 120 |
| Input signal from the HDMI input port..... | 121 |
| Specifications | 122 |
| • Projector General Specifications | 122 |
| • Operating Conditions for the Supplied Software | 124 |
| Appearance..... | 126 |
| Glossary..... | 127 |
| Index..... | 129 |

The projector supports the following four different projection methods. Install according to the conditions of the installation location.

Caution

- *A special method of installation is required when suspending the projector from a ceiling (ceiling mount). If it is not installed correctly, it could fall causing an accident and injury.*
- *If you use adhesives on the ceiling mount to prevent the screws from loosening, or if you use things such as lubricants or oils on the projector, the projector case may crack causing it to fall from its ceiling mount. This could cause serious injury to anyone under the ceiling mount and could damage the projector. When installing or adjusting the ceiling mount, do not use adhesives to prevent the screws from loosening and do not use oils or lubricants and so on.*

Attention

Do not use the projector on its side. This may cause malfunctions to occur.

- *Project images from in front of the screen. (Front projection)*

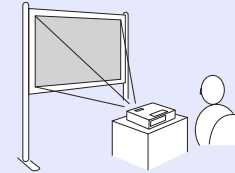

- *Project images from behind a translucent screen. (Rear projection)*

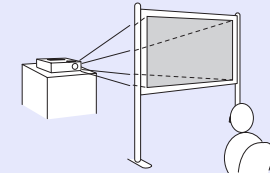

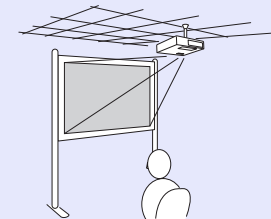

- *Suspend the projector from the ceiling and project images from in front of the screen. (Front/Ceiling projection)*

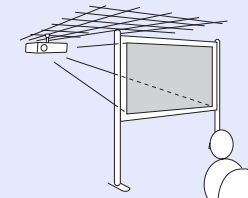

- *Suspend the projector from the ceiling and project images from behind a translucent screen. (Rear/Ceiling projection)*



- *An optional ceiling mount is required when suspending the projector from a ceiling.  p.90*
- *You can change the setting as follows by pressing down the [A/V Mute] button on the remote control for about five seconds.
"Front" ↔ "Front/Ceiling"
Set "Rear" or "Rear/Ceiling" from the configuration menu.  p.46*

You should clean the projector if it becomes dirty or if the quality of projected images starts to deteriorate.

Cleaning the Projector's Surface

Clean the projector's surface by wiping it gently with a soft cloth. If the projector is particularly dirty, moisten the cloth with water containing a small amount of neutral detergent, and then firmly wring the cloth dry before using it to wipe the projector's surface.

Attention

Do not use volatile substances such as wax, alcohol, or thinner to clean the projector's surface. The quality of the case may change or become discolored.

Cleaning the Lens

Use a commercially available cloth for cleaning glasses to gently wipe the lens.

Attention

Do not rub the lens with harsh materials or subject the lens to shocks, as it can easily become damaged.

Cleaning the Air Filter

Clean the air filter and the air intake vent when the following message is displayed.

"The projector is overheating. Make sure nothing is blocking the air vent, and clean or replace the air filter."

Attention

- *If dust collects on the air filter it can cause the internal temperature of the projector to rise, and this can lead to problems with operation and shorten the optical engine's service life. Clean the air filter immediately when the message is displayed.*
- *Do not rinse the air filter in water. Do not use detergents or solvents.*
- *When using a brush for cleaning, use one with long soft bristles, and brush it lightly. If it is brushed too strongly, dust will be ground into the air filter and cannot be removed.*

Procedure



1 Remove the air filter cover.

Grip the air filter cover tab between your fingers and pull it straight out.

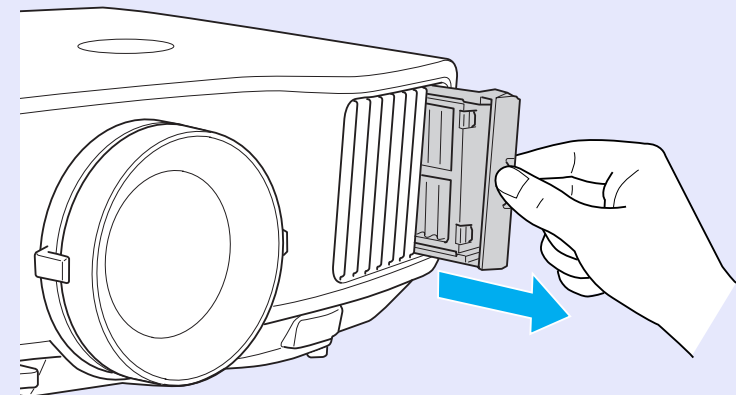

2 Remove the air filter.

Remove the air filter by placing your finger into the groove as shown in the following illustration.

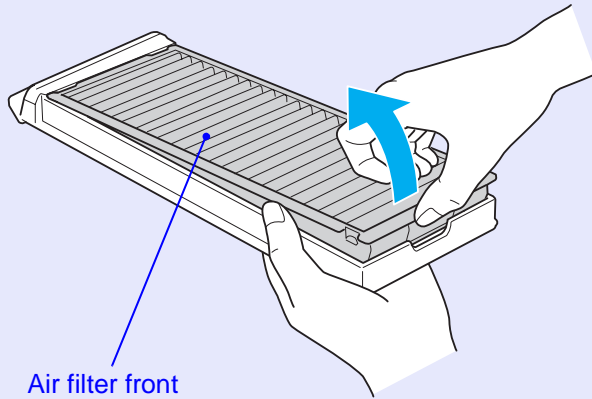

3 With the front of the air filter facing down, tap it four or five times to shake off the dust.

Turn it over and tap the other side in the same way to shake off the dust.

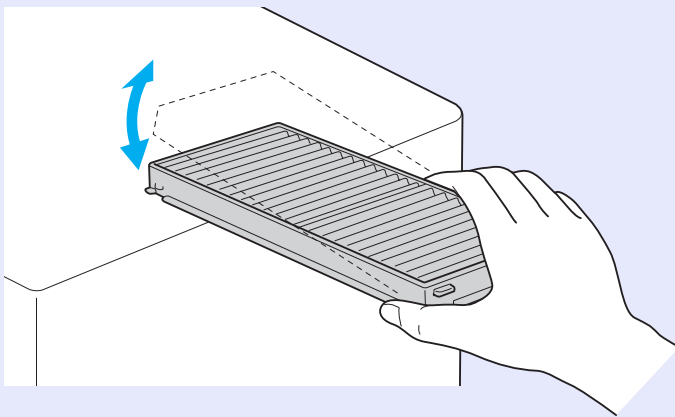

Attention

If the air filter is hit too hard, it may become unusable due to deformities and cracks.

4 Remove any dust remaining on the air filter by using a vacuum cleaner to clean the front.

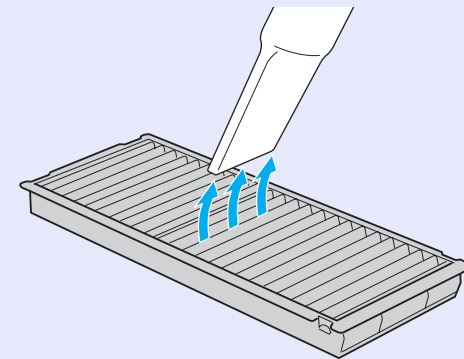

5 Insert the air filter back into the air filter cover.

Insert the projections on the air filter into the holes in the cover, and press it firmly into place.

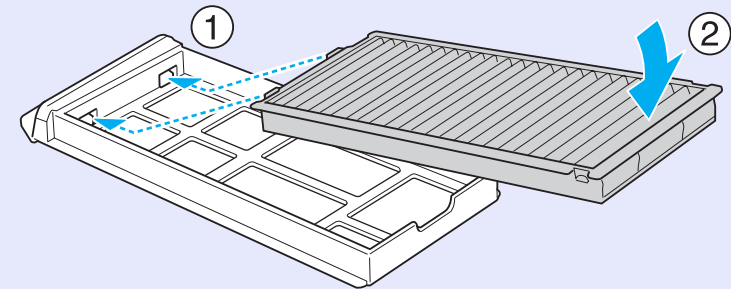

6**Replace the air filter cover.**

Press it in until you feel resistance.

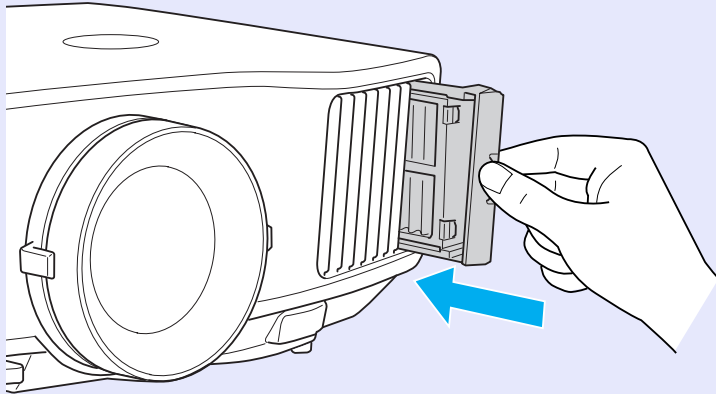

- *If a message is frequently displayed, even after cleaning, it is time to replace the air filter. Replace it with a new air filter. [p.88](#)*
- *It is recommended that you clean these parts at least once every three months. Clean them more often than this if using the projector in a particularly dusty environment.*

This section explains how to replace the remote control batteries, the lamp, and the air filter.

Replacing the Remote Control Batteries

If delays in the responsiveness of the remote control occur or if it does not operate after it has been used for some time, it probably means that the batteries are becoming flat. When this happens, replace them with new batteries. Have two spare AAA-size alkali batteries ready to use when required. You can only use AAA-size alkali batteries.

Attention

Make sure you read the *Safety Instructions/Support and Service Guide* before handling the batteries.  [Safety Instructions](#)

Procedure

1 Remove the battery cover.

While pushing the battery compartment cover catch, lift the cover up.

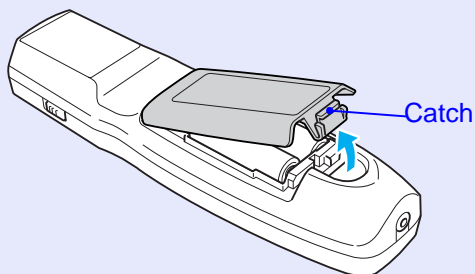

2 Replace the old batteries with new batteries.

⚠ Caution

Check the positions of the (+) and (-) marks inside the battery holder to ensure the batteries are inserted the correct way.

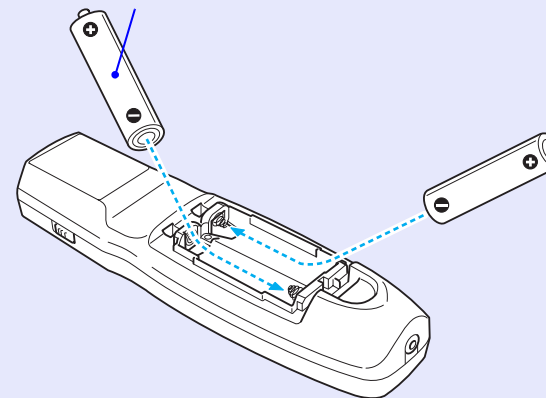

3 Replace the battery cover.

Press the battery compartment cover until it clicks into place.

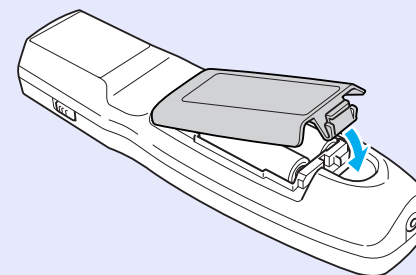

Replacing the Lamp

Lamp replacement period

It is time to replace the lamp when:

- The message "Replace the lamp. Replace the lamp." is displayed when you start projecting.

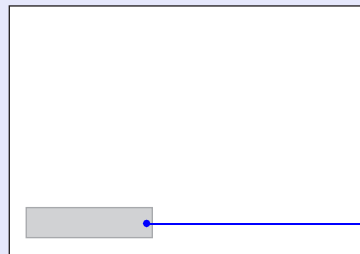

A message is displayed.

- The lamp indicator flashes orange.

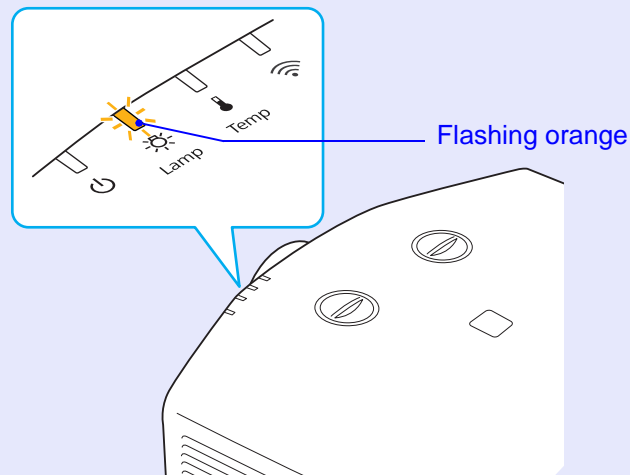

- The projected image gets darker or starts to deteriorate.

Attention

- *The lamp replacement message is set to appear after the following time periods in order to maintain the initial brightness and quality of the projected images.  "Brightness Control" p.44*
 When used continually at high brightness: About 1900 hours
 When used continually at low brightness: About 2900 hours
- *If you continue to use the lamp after the replacement period has passed, the possibility that the lamp may explode increases. When the lamp replacement message appears, replace the lamp with a new one as soon as possible, even if it is still working.*
- *Depending on the characteristics of the lamp and the way it has been used, the lamp may become darker or stop working before the lamp warning message appears. You should always have a spare lamp ready incase it is needed.*

How to replace the lamp

The lamp can be replaced even when the projector is suspended from a ceiling.

Warning

*When replacing the lamp because it has stopped illuminating, there is a possibility that the lamp may be broken.
 If replacing the lamp of a projector which has been installed on the ceiling, you should always assume that the lamp is broken, and you should stand to the side of the lamp cover, not underneath it.
 Remove the lamp cover gently.*

Caution

Wait until the lamp has cooled down sufficiently before removing the lamp cover. If the lamp is still hot, burns or other injuries may result. It takes about one hour after the power has been turned off for the lamp to be cool enough.

Procedure

1 After you turn off the projector's power and the confirmation buzzer beeps twice, disconnect the power cable.

2 Wait until the lamp has cooled down, then remove the projector's lamp cover.

Loosen the lamp cover fixing screw with the screwdriver supplied with the new lamp or a + head screwdriver, and then remove the lamp cover. Because there is a string attached to the lamp cover to prevent it from falling, it should never fall even when replacing the lamp in a projector installed on the ceiling.

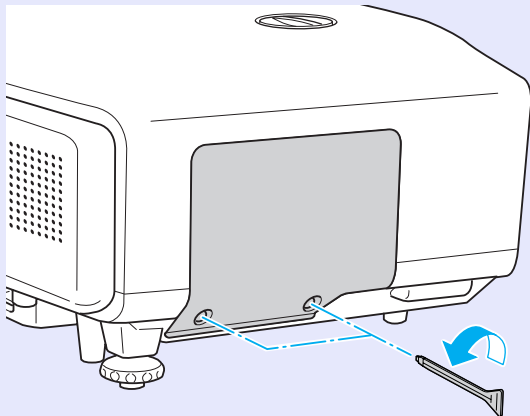

3 Loosen the two lamp fixing screws.

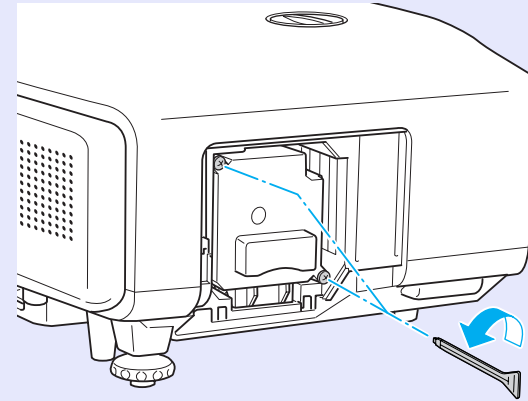

4 Take out the old lamp.

If the lamp is cracked, replace it with a new lamp, or contact your local dealer for further advice. [Epson Projector Contact List](#)

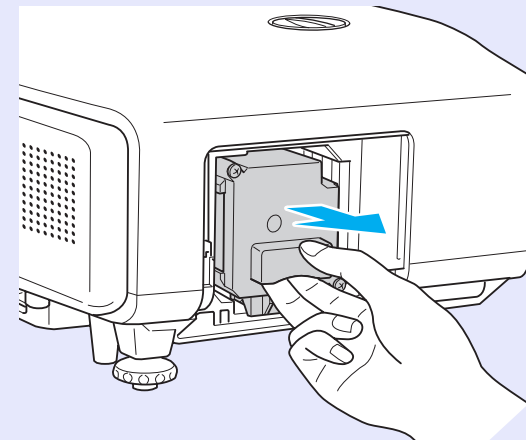

5 Install the new lamp.

Insert the new lamp along the guide rail in the correct direction so that it fits in place, push down firmly at the location marked "PUSH", and once it is fully inserted tighten the two screws.

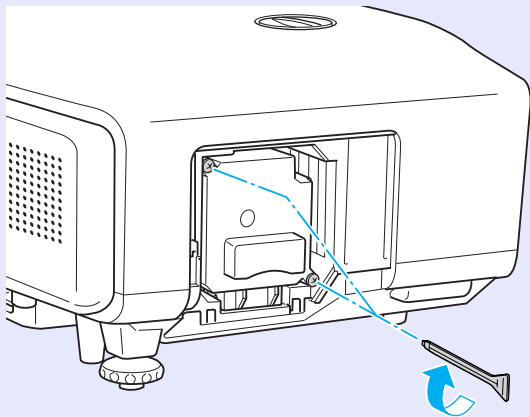
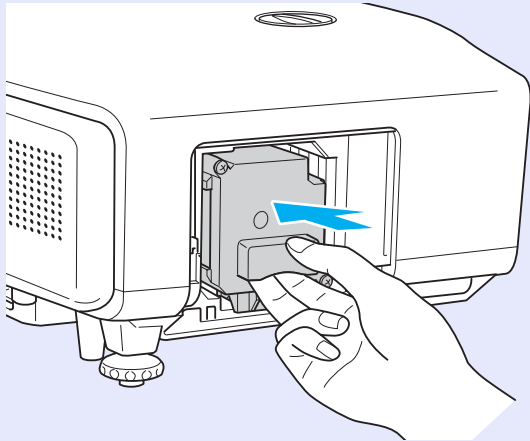

6 Replace the lamp cover.

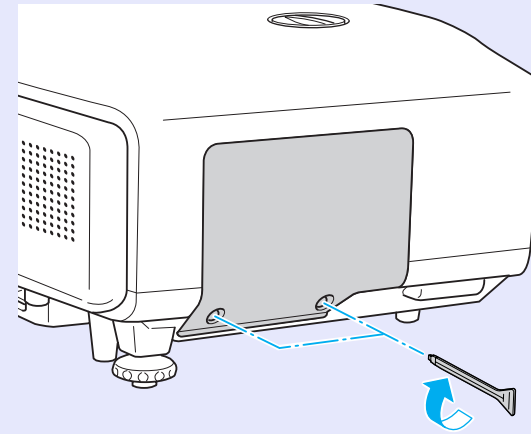

Attention

- *Make sure you install the lamp securely. If the lamp cover is removed, the lamp turns off automatically as a safety precaution. If the lamp or the lamp cover is not installed correctly, the lamp does not turn on.*
- *This product includes a lamp component that contains mercury (Hg). Please consult your local regulations regarding disposal or recycling. Dispose of used air filters properly in accordance with your local regulations.*

Resetting the lamp operating time

The projector records how long the lamp is turned on and a message and indicator notify you when it is time to replace the lamp. After replacing the lamp, make sure you reset the lamp hours from the configuration menu. p.64



Only reset the lamp operating time after the lamp has been replaced. Otherwise the lamp replacement period is not indicated correctly.

Replacing the Air Filter

Air filter replacement period

It is time to replace the air filter when:

- The air filter has been turned brown.
- The message is displayed even though the air filter has been cleaned.

How to replace the air filter

The air filter can be replaced even when the projector is suspended from a ceiling.

Procedure

1 Remove the air filter cover.

Grip the air filter cover tab between your fingers and pull it straight out.

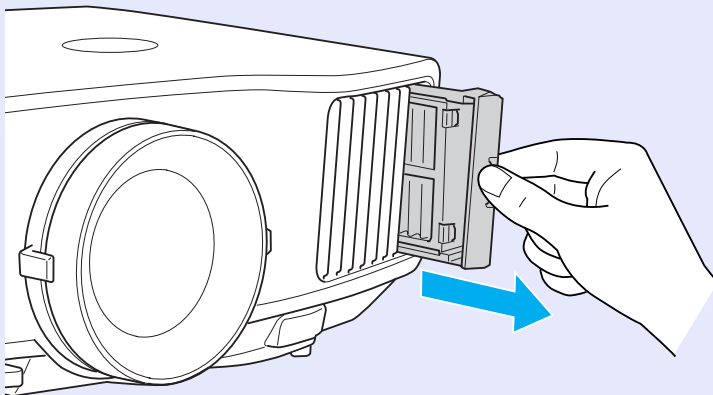

2 Remove the air filter.

Remove the air filter by placing your finger into the groove as shown in the following illustration.

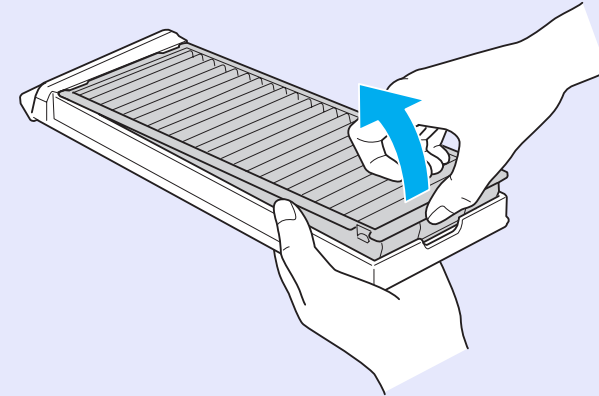

3 Insert the new air filter into the air filter cover.

Insert the projections on the air filter into the holes in the cover, and press it firmly into place.

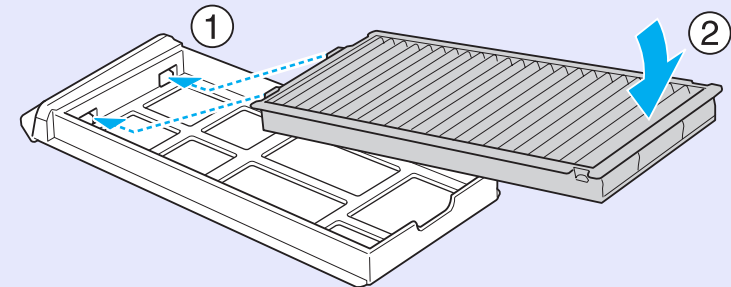

4

Replace the air filter cover.

Press it in until you feel resistance.

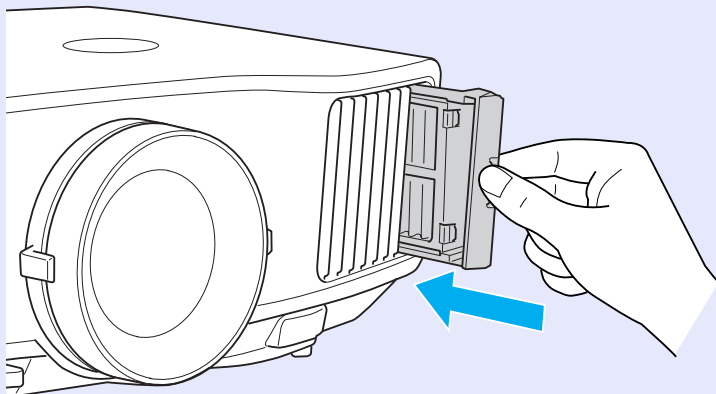

Dispose of used air filters properly in accordance with your local regulations.

Material quality of the frame section: Polypropylene

Material quality of the filter section: Polypropylene

The following optional accessories and consumables are available. Please purchase these products as and when needed. The following list of optional accessories and consumables is current as of: 2008.05. Details of accessories are subject to change without notice and availability may vary depending on the country of purchase.

■ Optional accessories

| | |
|--|---------|
| 60" portable screen | ELPSC07 |
| 80" portable screen | ELPSC08 |
| 100" screen | ELPSC10 |
| Portable roll-type screens (Aspect ratio ▶▶ 4:3) | |
| 50" portable screen ELPSC06 A compact screen that can be carried easily. (Aspect ratio 4:3) | |
| HD-15 cable ELPKC02 (1.8 m - for mini D-Sub15-pin/mini D-Sub 15pin) This is the same as the computer cable supplied with the projector. | |
| HD-15 cable ELPKC09 (3 m - for mini D-Sub15-pin/mini D-Sub 15pin) HD-15 PC cable ELPKC10 (20 m - for mini D-Sub15-pin/mini D-Sub 15pin) Use one of these longer cables if the computer cable supplied with the projector is too short. | |
| Component video cable ELPKC19 (3 m - for mini D-Sub 15-pin/RCA male×3) Use to connect a component video ▶▶ source | |
| Remote control cable set ELPKC28 (10m 2 piece set) Use this to guarantee operation from the remote control from a distance. | |
| Wireless mouse receiver ELPST16 Use this to operate a computer's mouse pointer using the projector's remote control, or to operate page Up/Down while projecting a PowerPoint file. | |
| Wireless LAN unit ELPAP03 (for EB-G5350/G5150) Use this to connect the projector to a computer by a wireless LAN and then project images. | |

| |
|--|
| Hard carrying case ELPKS58 Use this case if you need to travel with the projector. |
| Long focus zoom lens ELPLL06 (Projection distance ratio: For EB-G5350/G5300/G5150/G5100 Approx. 5.3 to 7.2 For EB-G5200W approx. 5.2 to 7.1) |
| Medium focus zoom lens ELPLM04 (Projection distance ratio: For EB-G5350/G5300/G5150/G5100 Approx. 2.4 to 3.6 For EB-G5200W approx. 2.3 to 3.5) |
| Medium focus zoom lens ELPLM05 (Projection distance ratio: For EB-G5350/G5300/G5150/G5100 Approx. 3.5 to 5.4 For EB-G5200W approx. 3.5 to 5.3) |
| Standard focus zoom lens ELPLS03 (Projection distance ratio: For EB-G5350/G5300/G5150/G5100 Approx. 1.3 to 2.4 For EB-G5200W approx. 1.3 to 2.3) |
| Wide lens for rear projection ELPLR03 (Projection distance ratio: For EB-G5350/G5300/G5150/G5100 Approx. 0.78 For EB-G5200W approx. 0.77) |
| Projection distance ratio = projection distance/projection screen width The values are installation standards. They are subject to change depending on projection conditions. |

Ceiling mount* ELPMB13

Use when installing the projector on a ceiling.

Ceiling plate* ELPFC03

Pipe 370 (370 mm silver)* ELPFP04

Pipe 570 (570 mm silver)* ELPFP05

Pipe770 (770 mm silver)* ELPFP06

Use when installing the projector on a ceiling.

A special method of installation is required to suspend the projector from a ceiling. Contact your dealer or the nearest address provided in the Support and Service Guide if you want to use this installation method.  [Epson Projector Contact List](#)

■ Consumables

Spare lamp ELPLP46 (EB-G5350/G5300/G5200W)

Spare lamp ELPLP47 (EB-G5150/G5100)

Use as a replacement for used lamps.

Air filter ELPAF17

Use as a replacement for used air filters.

There are many glass parts and precision components inside the projector. To prevent damage due to impacts when transporting, handle the projector as follows.

Moving Nearby

Checking the following points, and then carry carefully by the handle.

- Turn off the power to the projector and disconnect all cables.
- Attach the lens cover to the lens.
- Store the foot.

When Transporting

■ Preparing packaging

After checking the points in "Moving Nearby", prepare the following and then pack up the projector.

- Set the horizontal lens shift to the lowest position.
- Fit the protective lens pads that were used at the time of purchase.

■ Notes when packing and transporting

When packing, use the original packaging materials that were used at the time of purchase, or use a similar box and packing material.

If you no longer have the packaging, enclose the projector securely in insulation material to protect it from shock, and place it into a strong cardboard container which is clearly labeled as containing fragile equipment before shipping it.

When shipping the projector, make sure that the carrier company is equipped to transport fragile equipment, and be sure to notify them that the contents are fragile.

You can save the image that is currently being projected as a user's logo.



When a user's logo is saved, the previous user's logo is erased.

Procedure

- 1 Project the image you want to use as the user's logo, and then press the [Menu] button.

Using the remote control

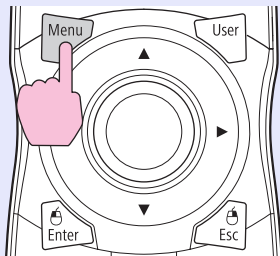

Using the control panel

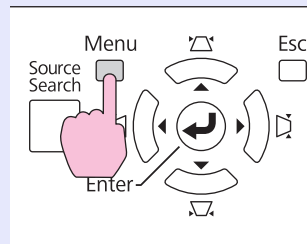

2

- 2 Select "Extended" - "User's Logo" from the configuration menu. "Using the Configuration Menu" p.40

Check the buttons you can use and the operations they perform in the guide under the menu.

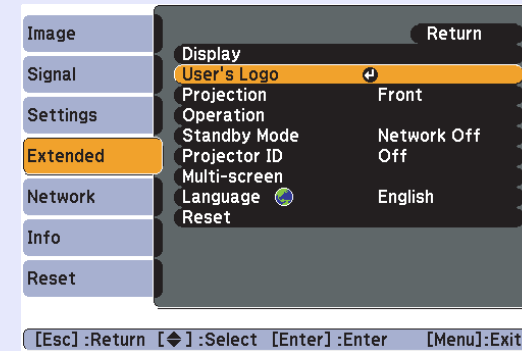

- If "User's Logo Protect" from "Password Protect" is set to "On", a message is displayed and the user's logo cannot be changed. You can make changes after setting "User's Logo Protect" to "Off". p.34
- If "User's Logo" is selected when Keystone, E-Zoom, Aspect, or Progressive are being performed, the function currently being performed is cancelled.

3

- 3 When "Choose this image as the User's Logo?" is displayed, select "Yes".



When you press the [Enter] button on the remote control or the control panel, the screen size may change according to the signal as it changes to the resolution of the image signal. The image is recorded and a selection marquee box is displayed.

- 4** Move the box to select the part of the image to use as the user's logo.

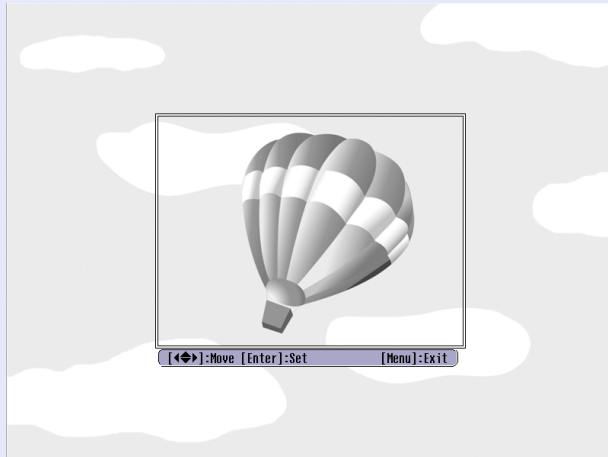

Using the remote control

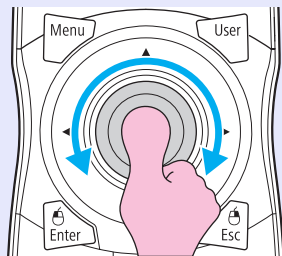

Using the control panel

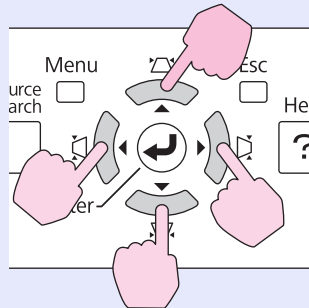

- 5** When "Select this image?" is displayed, select "Yes".
- 6** Select the zoom factor from the zoom setting screen.

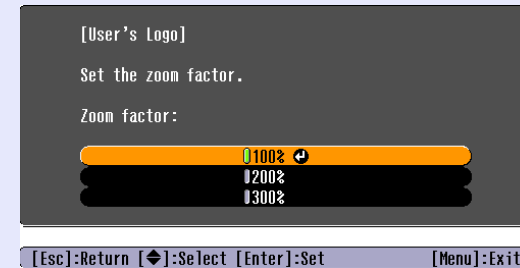

- 7** When the message "Save this image as the User's Logo?" is displayed, select "Yes".
- The image is saved. After the image has been saved, the message "Completed." is displayed.



- Saving the user's logo may take approximately 15 seconds. Do not use the projector or any connected equipment while it is saving, otherwise malfunctions may occur.
- Once a user's logo has been saved, the logo cannot be returned to the factory default.



You can save at up to 400 × 300 dots in size.

There are two methods for setting WPS.

- Push Button Method

SSID and security are set automatically when the [Enter] button is pressed on the projector's control panel and the dedicated button on the access point equipment. This method is recommended when the projector and access point are close together.

- PIN Code Method

SSID and security are set automatically by inputting an 8-digit code that was assigned to the projector from the computer to the access point in advance. Make connection settings between the computer and the access point in advance. For details on how to make this connection, refer to the manual provided with the access point. This method is recommended when the projector is mounted on the ceiling.

Connection Setup Method

Procedure

- 1 Press the [Menu] button on the projector, and then select "Network" - "Network Configuration" from the configuration menu.

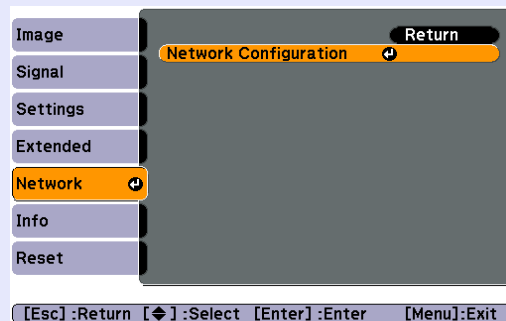

The Network Configuration screen is displayed.



- 2 From "Wireless LAN" select "Setup Wizard".



The following screen is displayed.

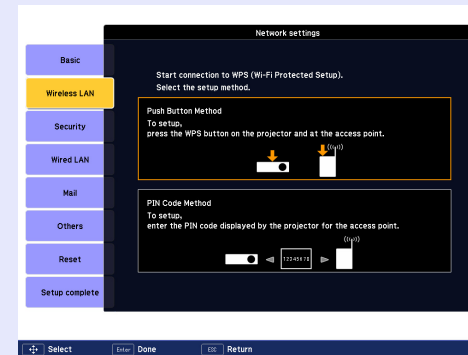

When connecting using the Push Button Method, follow the steps given below.

Go to "Making a connection using the PIN Code Method" when connecting using the "PIN Code Method".  [p.97](#)

■ Making a Connection Using the Push Button Method

Procedure

1 Select "Push Button Method".

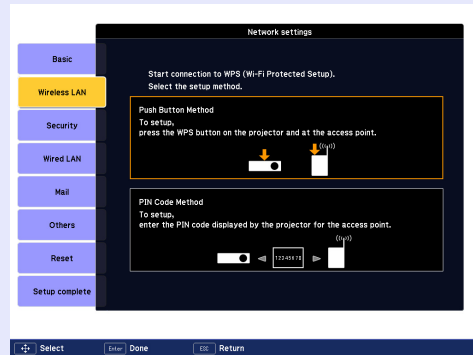

The Push Button Method screen is displayed.

2 Press the [Enter] button on the projector's control panel when prompted by the screen.

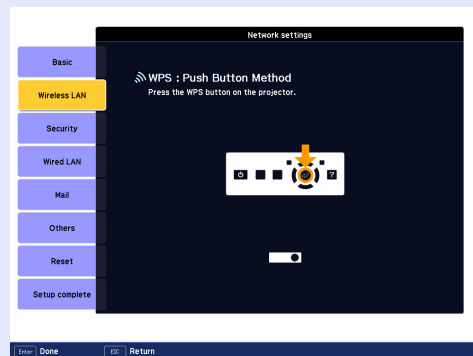

Then, the Push Button Method screen is displayed.

3 Press the button on the access point when prompted by the screen.

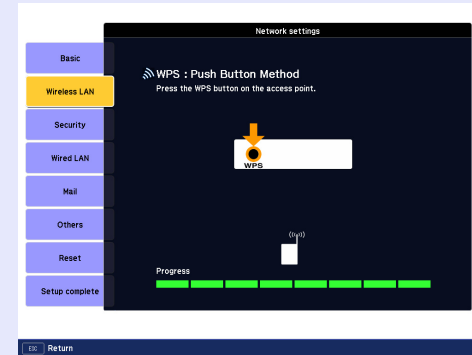

This completes the setup.

4 Press the [Enter] button or the [Esc] button.

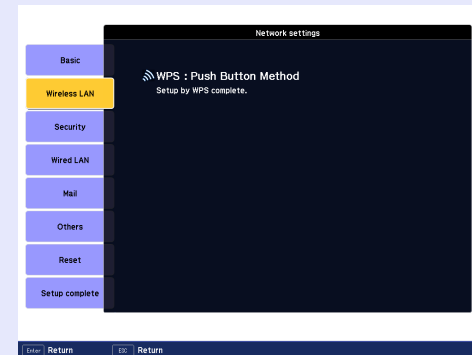

It returns to the Wireless LAN menu screen.

5 Select "Yes" from "Setup complete".



This completes the setup of the connection between the projector and the access point. Press the [Menu] button to close the configuration menu.

Making a connection using the PIN Code Method



Before you can make a connection using the "PIN Code Method", a connection must have already been setup between the computer and the access point.

Procedure



1 Select "PIN Code Method".

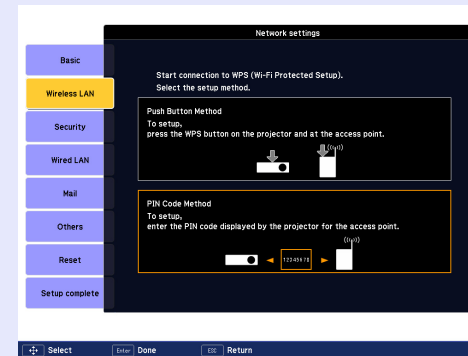

The PIN Code Method screen is displayed.

- Enter the PIN code displayed on the "PIN Code Method" screen from the computer to the access point, and then select "Start Setup".

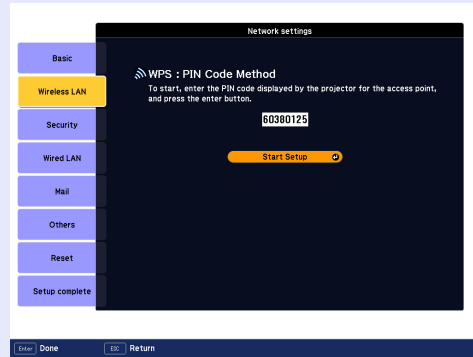

The progress is displayed.

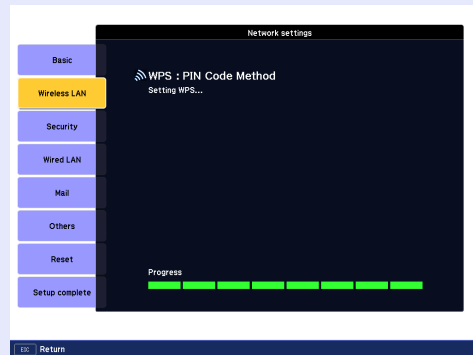

- The message "Setup by WPS complete." is displayed. Press the [Enter] button or the [Esc] button.

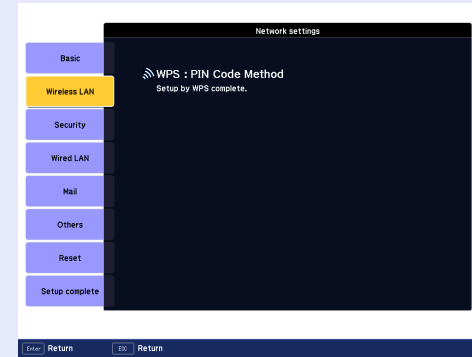

It returns to the Wireless LAN menu screen.

- Select "Yes" from "Setup complete".

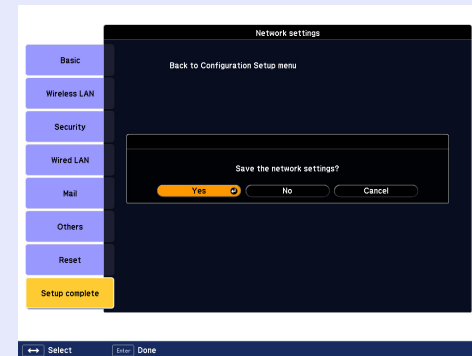

This completes the setup of the connection between the projector and the access point. Press the [Menu] button to close the configuration menu.

The following table shows the projection distance when a standard lens is attached. When an optional lens is attached, check the projection distances in the "Optional User's Guide" supplied with optional lenses. See the following table to choose the best position for your projector. The values are only a guide.

Projection Distance for EB-G5350/G5300/G5150/G5100

Units:cm(in.)

| 4:3 Screen Size | | Projection distance A | | B | |
|-----------------|------------------|------------------------------|----------------|----------------|----------------|
| | | Minimum (Wide) | Maximum (Tele) | Minimum (Wide) | Maximum (Tele) |
| 30" | 61×46(24×18) | 77~142(30~56) | | 0~46(0~18.0) | |
| 40" | 81×61(32×24) | 104~190(41~75) | | 0~61(0~24.0) | |
| 50" | 100×76(39×30) | 131~239(52~94) | | 0~76(0~30.0) | |
| 60" | 120×90(47×35) | 158~288(62~113) | | 0~91(0~36.0) | |
| 80" | 160×120(63×47) | 212~385(84~152) | | 0~122(0~48.0) | |
| 100" | 200×150(79×59) | 266~483(105~190) | | 0~152(0~60.0) | |
| 120" | 240×180(94×71) | 321~580(126~228) | | 0~183(0~72.0) | |
| 150" | 300×230(118×91) | 402~726(158~286) | | 0~229(0~90.0) | |
| 200" | 410×300(161×118) | 537~970(212~382) | | 0~305(0~120.0) | |
| 300" | 610×460(240×181) | 808~1457(318~573) | | 0~457(0~180.0) | |

Units:cm(in.)

| 16:9 Screen size | | Projection distance A | | B | |
|------------------|------------------|------------------------------|----------------|----------------------|----------------|
| | | Minimum (Wide) | Maximum (Tele) | Minimum (Wide) | Maximum (Tele) |
| 30" | 66×37(26×15) | 84~154(33~61) | | -6~44(-3~17.2) | |
| 40" | 89×50(35×20) | 113~207(45~82) | | -8~58(-3~22.9) | |
| 50" | 110×62(43×24) | 143~261(56~103) | | -10~73(-4~28.6) | |
| 60" | 130×75(51×25) | 172~314(68~123) | | -12~87(-5~34.3) | |
| 80" | 180×100(71×39) | 231~420(91~165) | | -17~116(-7~45.8) | |
| 100" | 220×120(87×47) | 290~526(114~207) | | -21~145(-8~57.2) | |
| 120" | 270×150(106×59) | 349~632(138~249) | | -25~174(-9.8~68.6) | |
| 150" | 330×190(130×75) | 438~791(172~311) | | -31~218(-12~85.8) | |
| 200" | 440×250(173×98) | 586~1056(231~416) | | -42~291(-16~114.4) | |
| 275" | 610×340(240×134) | 808~1457(318~573) | | -57~400(-22.5~157.5) | |

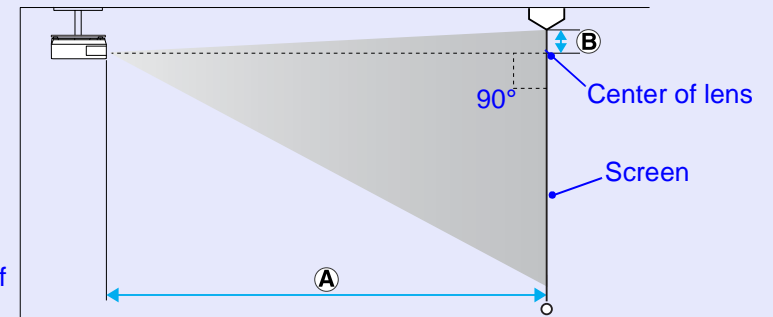
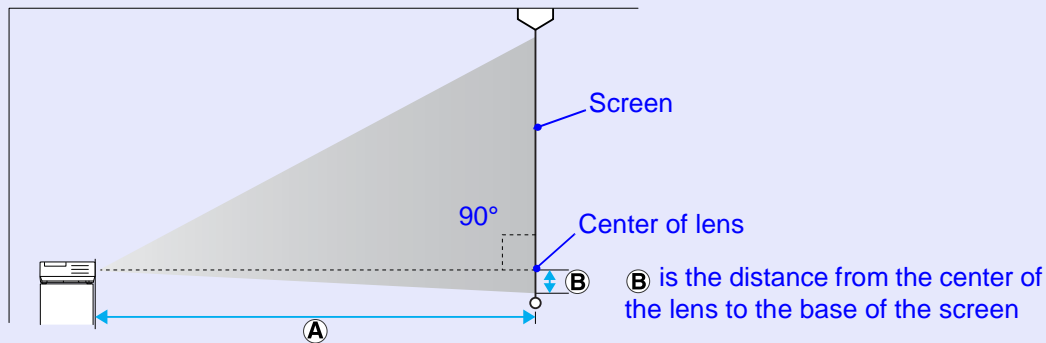

Projection Distance for EB-G5200W

Units:cm(in.)

| 4:3 Screen Size | | Projection distance A | B |
|-----------------|----------------------|----------------------------------|----------------------------------|
| | | Minimum (Wide) to Maximum (Tele) | Minimum (Wide) to Maximum (Tele) |
| 30" | 61×46 (24×18) | 92~169 (36~67) | -4~50 (-1.7~19.7) |
| 40" | 81×61 (32×24) | 124~227 (49~89) | -6~67 (-2.3~26.3) |
| 50" | 100×76 (39×30) | 156~285 (62~112) | -7~83 (-2.9~32.9) |
| 60" | 120×90 (47×35) | 189~343 (74~135) | -9~100 (-3.4~39.4) |
| 80" | 160×120 (63×47) | 253~459 (100~181) | -12~134 (-4.6~52.6) |
| 100" | 200×150 (79×59) | 318~575 (125~226) | -15~167 (-5.7~65.7) |
| 120" | 240×180 (94×71) | 382~691 (150~272) | -17~200 (-6.9~78.9) |
| 150" | 300×230 (118×91) | 479~864 (189~340) | -22~250 (-8.6~98.6) |
| 200" | 410×300 (161×118) | 640~1154 (252~454) | -29~334 (-11.4~131.4) |
| 265" | 540×400 (213×157) | 851~1532 (335~603) | -38~442 (-15.1~174.1) |

Units:cm(in.)

| 16:9 Screen size | | Projection distance A | B |
|------------------|----------------------|----------------------------------|----------------------------------|
| | | Minimum (Wide) to Maximum (Tele) | Minimum (Wide) to Maximum (Tele) |
| 30" | 66×37 (26×15) | 83~153 (33~60) | -6~43 (-2.4~17.1) |
| 40" | 89×50 (35×20) | 113~206 (44~81) | -8~58 (-3.2~22.8) |
| 50" | 110×62 (43×24) | 142~259 (56~102) | -10~72 (-4.0~28.5) |
| 60" | 130×75 (51×25) | 171~311 (67~123) | -12~87 (-4.7~34.2) |
| 80" | 180×100 (71×39) | 230~417 (90~164) | -16~116 (-6.3~45.5) |
| 100" | 220×120 (87×47) | 288~522 (114~205) | -20~145 (-7.9~56.9) |
| 120" | 270×150 (106×59) | 347~627 (137~247) | -24~174 (-9.5~68.3) |
| 150" | 330×190 (130×75) | 435~785 (171~309) | -30~217 (-11.9~85.4) |
| 200" | 440×250 (173×98) | 581~1048 (229~413) | -40~289 (-15.8~113.9) |
| 290" | 640×360 (252×142) | 851~1532 (335~603) | -59~422 (-23.1~166.2) |

Units:cm(in.)

| 16:10 Screen size | | Projection distance A | B |
|-------------------|----------------------|----------------------------------|----------------------------------|
| | | Minimum (Wide) to Maximum (Tele) | Minimum (Wide) to Maximum (Tele) |
| 30" | 66×41 (26×16) | 81~149 (32~59) | -4~44 (-1.5~17.4) |
| 40" | 89×56 (35×22) | 110~200 (43~79) | -5~59 (-2.0~23.2) |
| 50" | 110×67 (43×26) | 138~252 (54~99) | -6~74 (-2.5~29.0) |
| 60" | 130×81 (51×32) | 167~303 (66~119) | -8~88 (-3.0~34.8) |
| 80" | 180×110 (71×43) | 224~405 (88~160) | -10~118 (-4.0~46.4) |
| 100" | 220×130 (87×51) | 281~508 (110~200) | -13~147 (-5.0~58.0) |
| 120" | 270×169 (106×67) | 338~610 (133~240) | -15~177 (-6.1~69.7) |
| 150" | 330×206 (130×81) | 423~764 (167~301) | -19~221 (-7.6~87.1) |
| 200" | 440×275 (173×108) | 566~1020 (223~401) | -26~295 (-10.1~116.1) |
| 300" | 550×344 (267×135) | 851~1532 (335~603) | -38~442 (-15.1~174.1) |

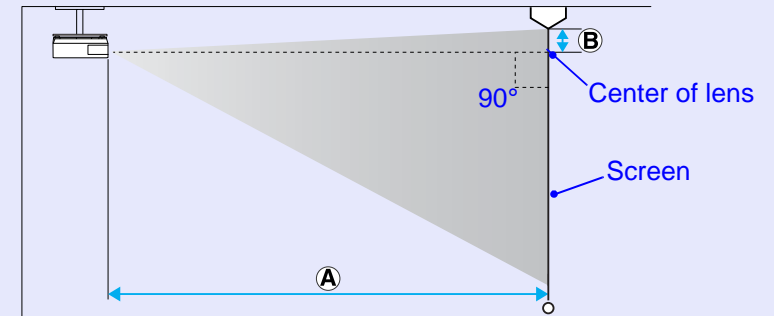
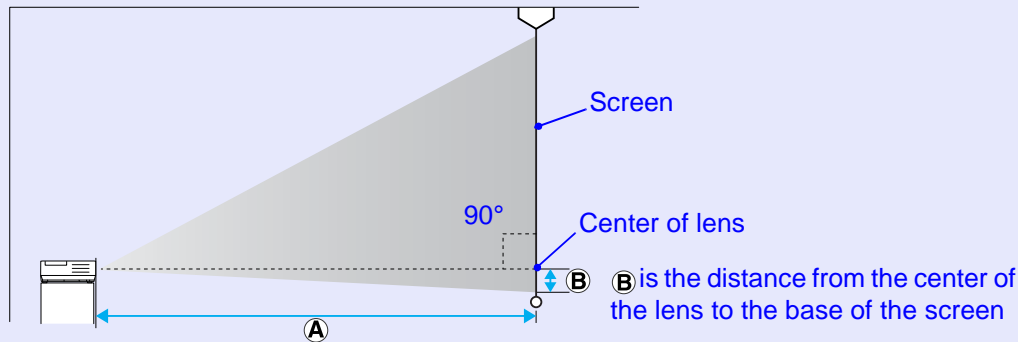

Connecting to an External Monitor

Computer images being input to the Computer1/2 or BNC input ports can be displayed on an external monitor and the screen at the same time when connected to the projector. This means that you can check projected images on an external monitor when giving presentations even if you cannot see the screen.

Connect to an external monitor using the cable supplied with the monitor.

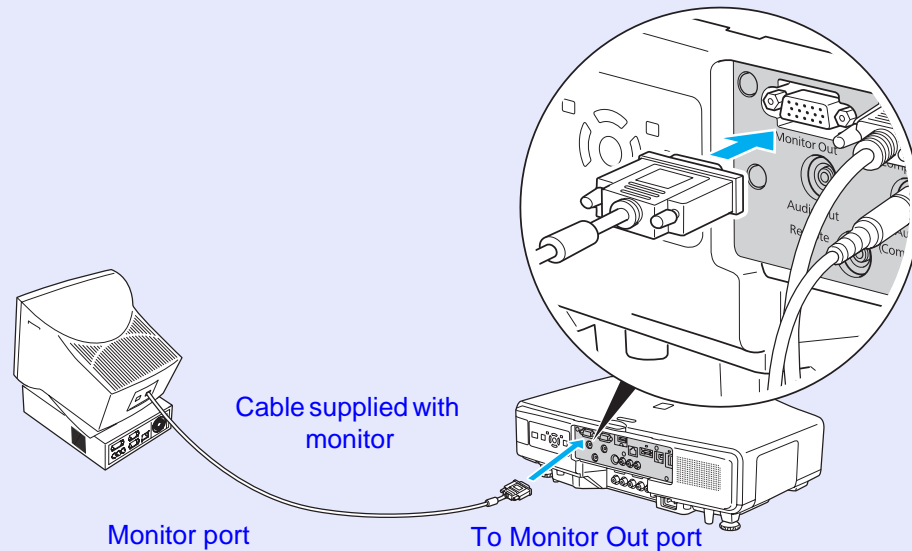

- *Component video signals and equipment connected to the Video1/2, S-Video, and HDMI input ports cannot be output to an external monitor.*
- *Setting gauges such as Keystone, the configuration menu and help screens are not output to an external monitor.*

Connecting to External Speakers

You can connect speakers with built-in amplifiers to the projector's Audio Out port to enjoy a fuller quality of sound.

Connect with a commercially available audio cable (pin plug ↔ 3.5 mm stereo mini plug and so on). Use an audio cable compatible with the connector on the external speakers.

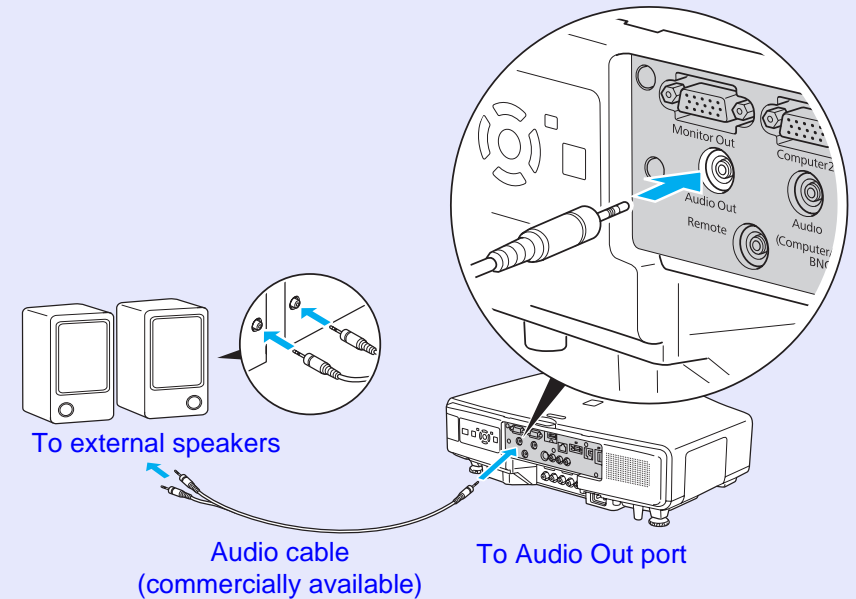

- *When an audio cable plug is inserted in the Audio Out port, the audio changes to the external destination, and audio is no longer emitted from the projector's built-in speaker.*
- *When using a commercially available 2RCA(L•R)/stereo mini-pin audio cable, make sure it is labeled "No resistance".*

Removing

Attention

- Only remove the lens unit when necessary. If dust or garbage enter the projector, projection quality deteriorates and it could cause a malfunction.
- Try not to touch the lens section with your hand or fingers. If fingerprints or oils are left on the surface of the lens, projection quality deteriorates.
- If it is fixed in place, remove the Screw to fix the lens unit removal button.

Procedure

- 1 Hold down the lens unit removal button and turn the lens anti-clockwise until you hear it click.

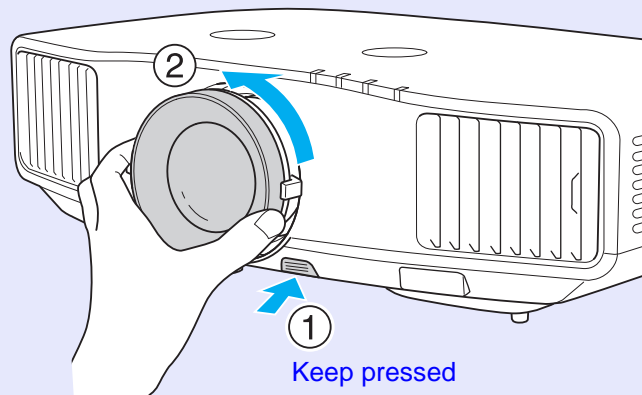

- 2 Remove the lens unit by pulling it straight out.

Attaching

Attention

Do not attach the lens unit when the projector's lens insertion section is facing up. Dust or garbage could enter the projector.

Procedure

- 1 Turn clockwise until the focus ring stops moving.

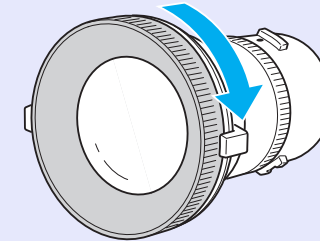

- 2** Insert the lens unit straight into the lens insertion section with the white circle on the lens on top, and then turn clockwise until you hear it click into place.

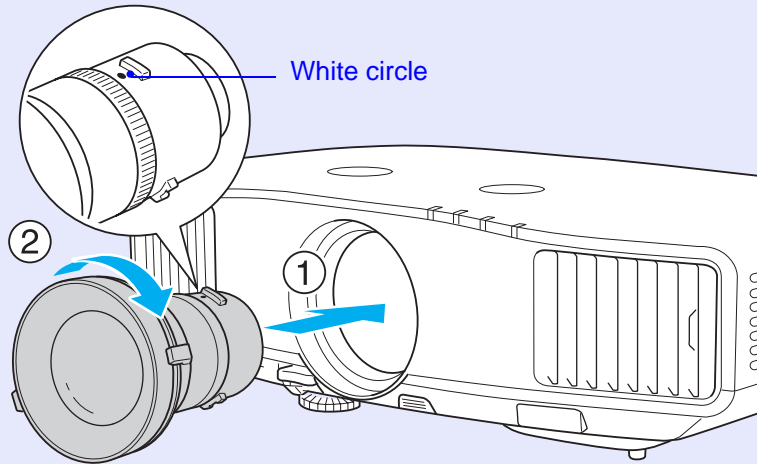

- 3** Check that the lens cannot be detached by turning it anti-clockwise.

USB 2.0/1.1-compatible digital cameras, hard disk drives and USB storage devices can be connected to the projector. Image files that are stored inside the digital camera and scenarios, images and movies that are stored inside USB storage devices can be played back by EasyMP PC Free.

☞ [EasyMP Operation Guide "PC Free Basic Operations"](#)

Connecting USB Devices

The following procedure describes how to connect USB devices, using a digital camera as an example.

Connect a digital camera to the projector using a USB cable provided with, or specified for use with your digital camera.



Use a USB cable less than 3m in length. If the cable exceeds 3m, PC Free may not function correctly.

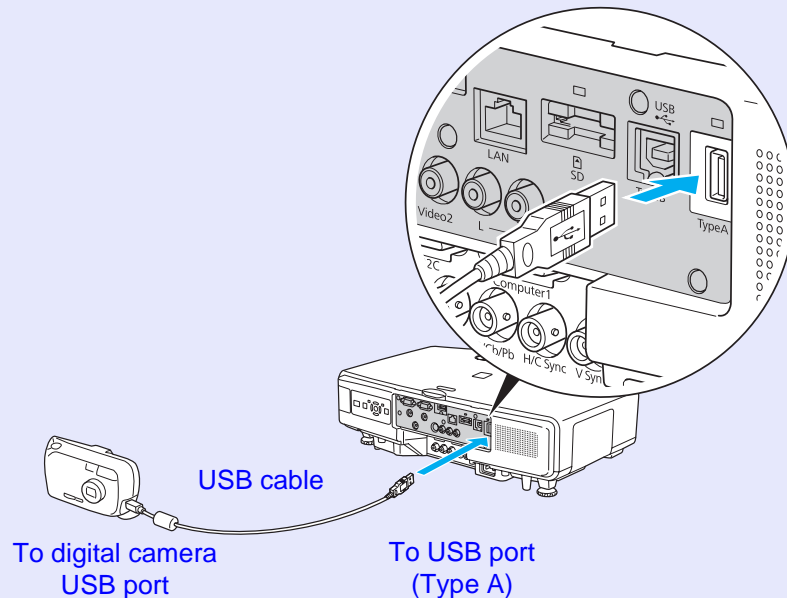

Attention

- *If you use a USB hub, the connection may not operate correctly. Devices such as digital cameras and USB storage devices should be connected to the projector directly.*
- *When connecting and using a USB-compatible hard disk, make sure you connect the AC adaptor supplied with the hard disk.*

Reading the USB Indicators

The USB indicator colors are lit as follows to indicate the status of the USB device connected to the projector.

■ : Lit □ : Off

| Indicators | Status |
|------------|--------------------------------|
| ■ (Orange) | A USB device is connected. |
| ■ (Green) | PC Free is running. |
| □ | A USB device is not connected. |

Removing USB Devices

After finishing projecting, use the following procedure to remove USB devices from the projector.

Procedure

- 1 Turn off power for the digital camera or USB storage device.
- 2 Remove from the projector's USB port (Type A).

You can project image/movie files saved on SD memory cards and SDHC (SD High Capacity) cards with PC Free in EasyMP by connecting those devices to the projector. [EasyMP Operation Guide "PC Free Basic Operations"](#)

From here on these are referred to as SD cards.

The following explains how to insert and eject SD cards.

Inserting

Attention

Insert the SD card so that it faces the correct direction. Inserting a card in the wrong direction may result in malfunction or damage.

Procedure

Insert the SD card into the card slot with its top surface facing up.

Firmly insert the card as far as it can go.

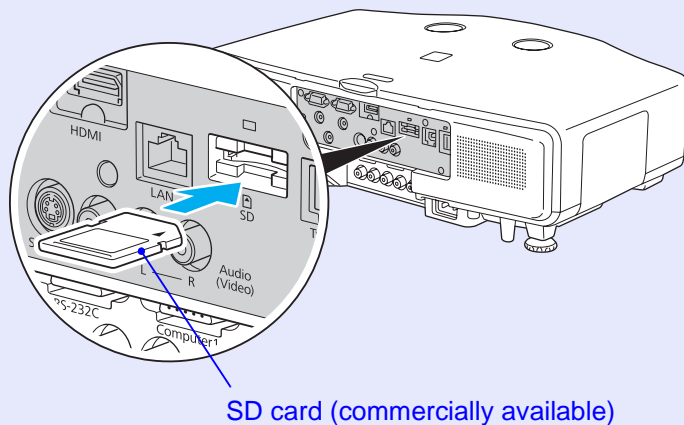

Reading the SD Card Access Lamp

The SD card access lamp is lit or flashing as follows to indicate the access status of the SD card.

: Flashing : Lit: : Off

| Lamp | Status |
|------|---|
| | Reading or writing data to the SD card. |
| | The SD card is standing by. |
| | The SD card is not performing any operations. |

Removing

Attention

Do not remove the card while its indicator light is green or is flashing. You may damage the card or projector.

Procedure

1 Gently press the SD card.

The SD card springs out.

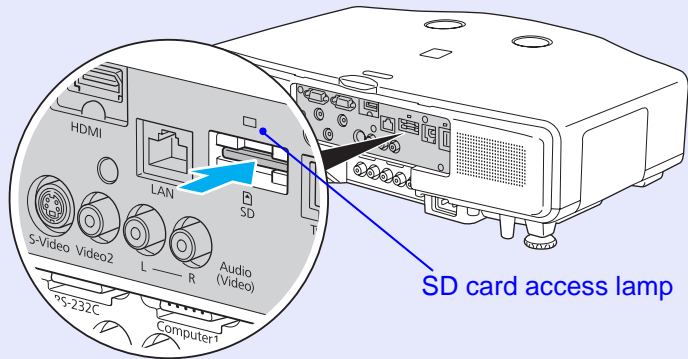

2 Remove the SD card by pulling it straight out.

Connecting a LAN Cable



Connect with a commercially available 100BASE-TX or 10BASE-T type LAN cable. The following illustration shows an example of the EB-G5350/5150. Depending on the model you are using, the interface may differ, for example there may not be an SD card slot.

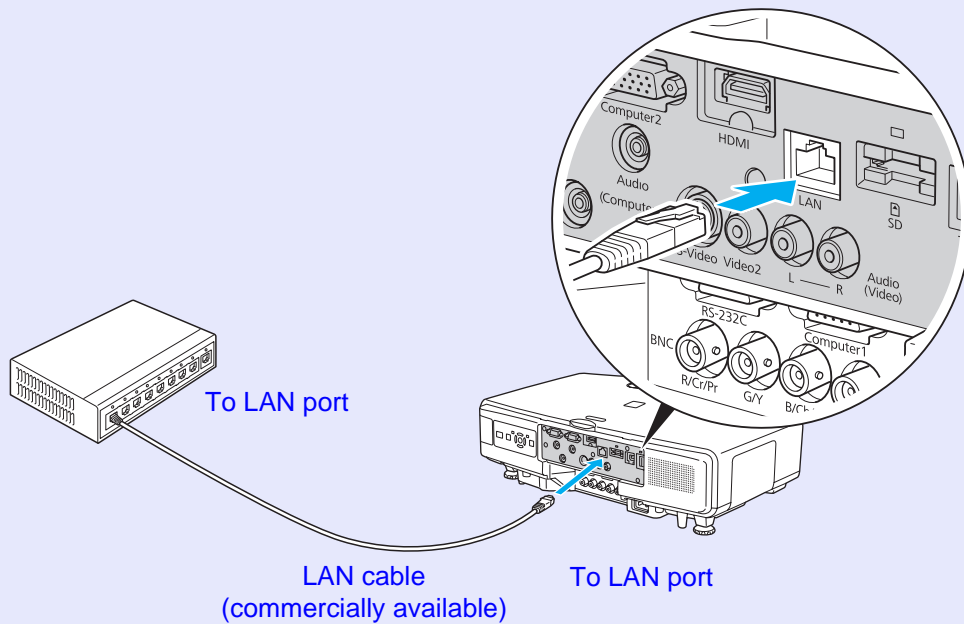

Attention

To prevent malfunctions, use a category 5 shielded LAN cable.

By using a commercially available USB cable to connect the projector to a Windows computer you can project images from the computer. This function is called USB Display. Simply by connecting via a USB cable, images from the computer can be displayed.

Attention

Connect the projector directly to the computer and not via a USB hub.

Connecting

Procedure

1 Turn the computer on.

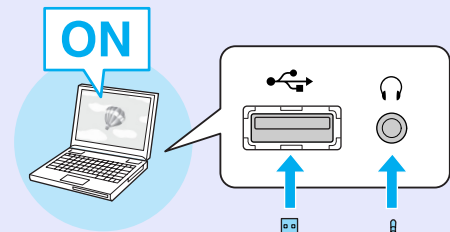

5 Connects to the USB cable.

Connect an audio cable when outputting audio from the projector's speaker.

☞ "Connecting for the first time" p.109

☞ "From the second time" p.110

4 Remove the lens cover.

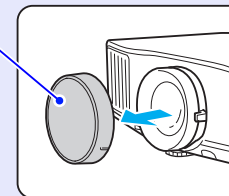

3 Turn the projector on.

2 Connects to the power cable (supplied).

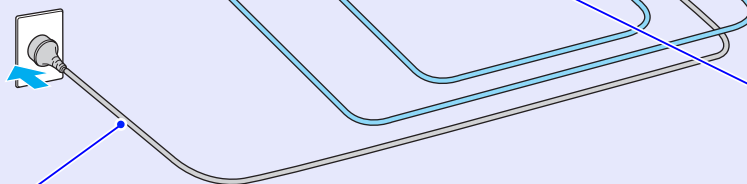

Beep

Using the control panel

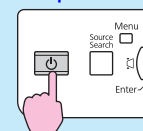

Using the remote control

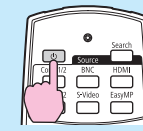

■ Connecting for the first time

1 Driver installation starts automatically.

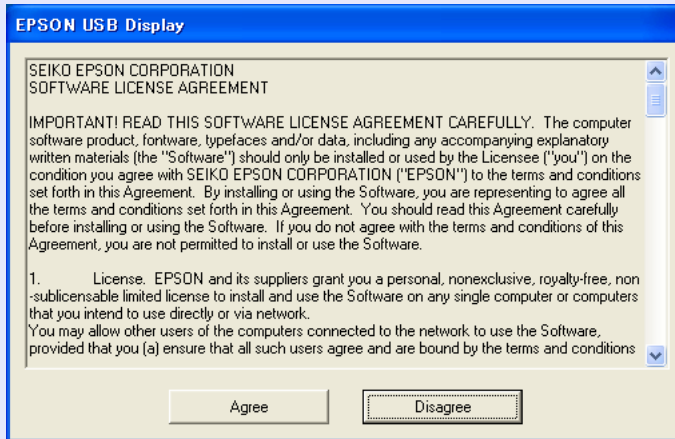

When using a computer running Windows 2000 under user authority, a Windows error message is displayed during installation and you may not be able to install the software. In this case, try updating Windows to the latest status, restart, and then try to connect again. For more details, contact the nearest address provided in the Support and Service Guide. [Epson Projector Contact List](#)

2 Click "Agree".

If the driver is not installed, you cannot start USB Display. Select "Agree". If you want to cancel installation, click "Disagree".

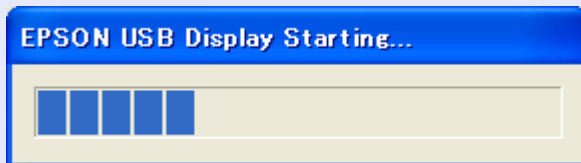

3 Computer images are projected.

It may take a while before computer images are projected. Until computer images are projected, leave the equipment as it is and do not disconnect the USB cable or turn off the power to the projector.

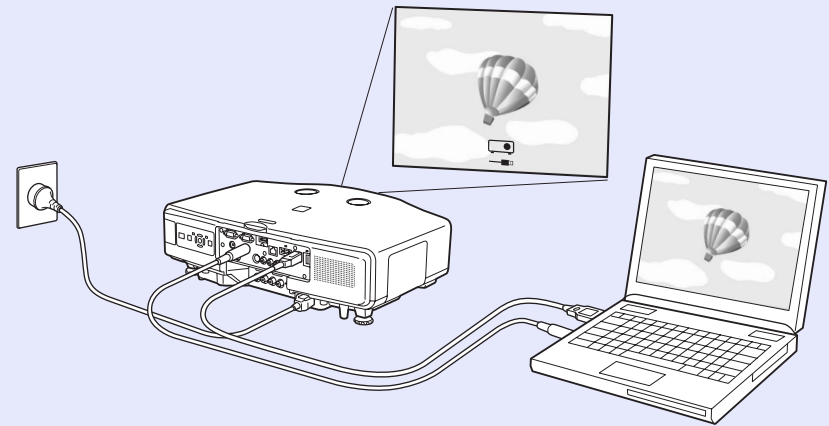

- *If for some reason nothing is projected, click "All Programs" - "EPSON Projector" - "EPSON USB Display" - "EPSON USB Display Vx.x", on your computer.*
- *If it is not installed automatically, double-click "My Computer" - "EPSON_PJ_UD" - "EMP_UDSE.EXE", on your computer.*
- *To uninstall the driver, click "Start" menu - "EPSON USB Display" - "Remove EPSON USB Display", on your computer.*
- *Disconnecting*
The projector can be disconnected simply by disconnecting the USB cable. There is no need to use the "Safely Remove Hardware" feature in Windows.



■ **From the second time**

Computer images are projected.

It may take a while before computer images are projected. Please wait.

When the Mail Notification function is set to "On" and a problem/warning occurs in the projector, the following e-mail is sent.

Subject: EPSON Projector

Line 1: The name of the projector where the problem has occurred

Line 2: The IP address set for the projector where the problem has occurred.

Line 3 and on: Details of the problem

The details of the problem are listed line by line. The following table shows the details that are given in the message for each item.

To deal with problems/warnings, see "Reading the Indicators"

( p.67).

| Message | Cause |
|--------------------------------|--|
| Internal error | Internal Error |
| Fan related error | Fan Error |
| Sensor error | Sensor Error |
| Lamp cover is open. | Lamp Cover Open |
| Lamp timer failure | Lamp Failure |
| Lamp out | Lamp Error |
| Power Err. (Ballast) | Power Err. (Ballast) |
| Internal temperature error | High Temp Error (Overheating) |
| High-speed cooling in progress | High Temp Warning |
| Lamp replacement notification | Replace Lamp |
| No-signal | No Signal No Signal is input to the projector. Check the connection status or check that the power for the signal source is turned on. |

A (+) or (-) appears at the start of the message.

(+): A projector problem has occurred

(-): A projector problem has been dealt with

Command List

When the power ON command is transmitted to the projector, the power turns on and it enters warm-up mode. When the projector's power has turned on, a colon ":" (3Ah) is returned.

When a command is input, the projector executes the command and returns a ":", and then accepts the next command.

If the command being processed terminates abnormally, an error message is output and a ":" is returned.

| Item | Command | | |
|------------------|-----------------------------|-----------|-----------|
| Power ON/OFF | ON | PWR ON | |
| | OFF | PWR OFF | |
| Signal selection | Computer1 | Auto | SOURCE 1F |
| | | RGB | SOURCE 11 |
| | | Component | SOURCE 14 |
| | Computer2 | Auto | SOURCE 2F |
| | | RGB | SOURCE 21 |
| | | Component | SOURCE 24 |
| | BNC | Auto | SOURCE BF |
| | | RGB | SOURCE B1 |
| | | Component | SOURCE B4 |
| | Video1 | SOURCE 45 | |
| | Video2 | SOURCE 41 | |
| | S-video | SOURCE 42 | |
| | HDMI | SOURCE 30 | |
| | EasyMP(EB-G5350/G5150 only) | SOURCE 50 | |

| Item | Command | |
|--------------------|---------|----------|
| A/V Mute ON/OFF | ON | MUTE ON |
| | OFF | MUTE OFF |
| A/V Mute selection | Black | MSEL 00 |
| | Blue | MSEL 01 |
| | Logo | MSEL 02 |

* Add a Carriage Return (CR) code (0Dh) to the end of each command and transmit.

Cable Layouts

Serial connection

- Connector shape : D-Sub 9-pin (male)
- Projector input connector : RS-232C

<At the projector>



<At the computer>

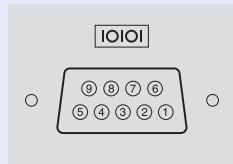

At the projector (PC serial cable) At the computer

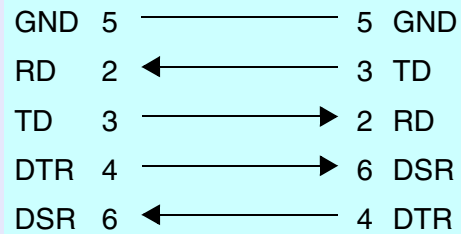

| Signal | Function |
|--------|---------------------|
| GND | Signal wire ground |
| TD | Transmit data |
| RD | Receive data |
| DSR | Data set ready |
| DTR | Data terminal ready |

Communications protocol

- Default baud rate setting : 9600bps
- Data length : 8bit
- Parity : None
- Stop-bit : 1bit
- Flow control : None

There are two methods connecting the projector to a computer via a network and project images from the computer screen.

- By "EMP NS Connection"

The EMP NS Connection application on the supplied EPSON Projector Software for Meeting&Presentation provides a wide range of features for use in meetings and presentations, such as a distribution function, multi-screen display, movie sending mode, and a presentation mode. By using "EMP NS Connection", you can not only project, but also hold successful meetings and make presentations simply by connecting the projector to a computer. [EasyMP Operation Guide](#)

- By "Network Projector"

"Network projector" is a standard function in Windows Vista. Therefore, you can project images from the computer by detecting the projector on the network only by using a function of the OS without having to install any special software.

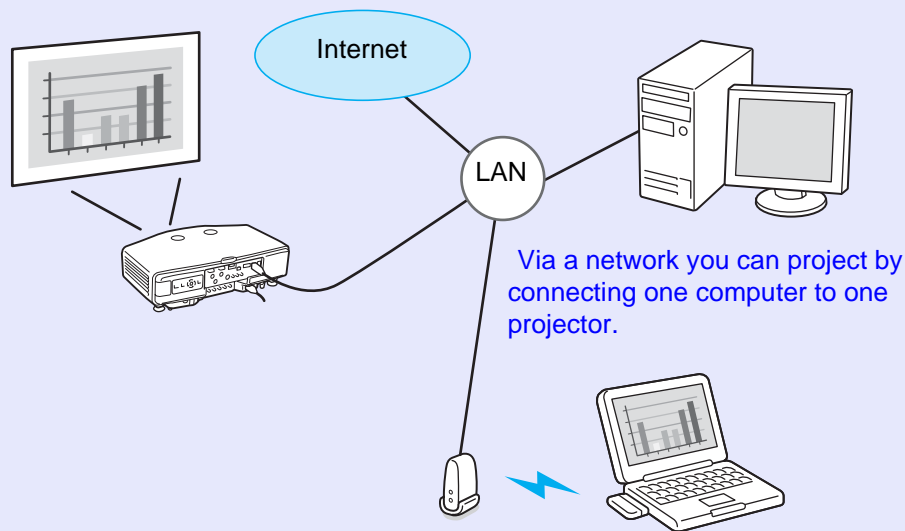

Compatible OS

Windows: Vista Home Premium/Vista Business/Vista Enterprise/Vista Ultimate

This section provides an easy explanation of "Network Projector".

Check that the projector and computer are connected to the network, and carry out the following operations.

Procedure

- 1 Turn the projector on, and then press the [EasyMP] button on the remote control.**

- 2 On the computer, start Windows, and then click "Start" - "All programs" - "Accessories" - "Network projector".**

The connection setting screen is displayed.

The projector is identified by inputting its IP address, or by allowing the OS to automatically identify all of the connected projectors.

- 3 Once the OS has identified all of the connected projectors, select the one that you want to use and click "Connect".**

When the projector password screen is displayed, enter the Projector keyword shown at the bottom of the EasyMP standby screen. [EasyMP Operation Guide "Preparing the Projector"](#)



When using "Network Projector" from "Options" in Windows Meeting Space, set the colors for the computer screen you are using to the highest level (32bit). If it is not capable of a 32bit display, a message is displayed and you cannot connect.

PJLink Class 1 was established by the JBMIA (Japan Business Machine and Information System Industries Association) as a standard protocol for controlling network-compatible projector's as part of their efforts to standardize projector control protocols.

The projector complies with the PJLink Class 1 standard established by the JBMIA.

It complies with all commands except for the following commands defined by PJLink Class 1, and agreement was confirmed by the PJLink standard adaptability verification.

URL <http://pjlink.jbmia.or.jp/english/>

■ Non-compatible commands

| Function | | PJLink Command |
|---------------|---------------------|----------------|
| Mute settings | Image muting set | AVMT 11 |
| | Image muting cancel | AVMT 10 |
| | Audio muting set | AVMT 21 |
| | Audio muting cancel | AVMT 20 |

■ Input names defined by PJLink and corresponding projector connectors

| Input Connector | PJLink Command |
|-----------------|----------------|
| Computer1 input | INPT 11 |
| Computer2 input | INPT 12 |
| BNC input | INPT 13 |
| Video1 input | INPT 23 |
| Video2 input | INPT 21 |
| S-Video input | INPT 22 |
| HDMI input | INPT 32 |
| EasyMP | INPT 51 |

■ **Manufacturer name displayed for "Manufacture name information query"**
EPSON

■ **Model name displayed for "Product name information query"**
EB-G5350
EB-G5300
EB-G5200W
EB-G5150
EB-G5100

Supported Monitor Displays for EB-G5350/G5300/G5150/G5100

■ Computer signals (analog RGB)

Units: dots

| Signal | Refresh rate (Hz) | Resolution | Aspect mode | | | |
|--------|-----------------------|---------------------|-------------|----------|----------|----------|
| | | | Normal | 4:3 | 16:9 | Through |
| VGAEGA | 70 | 640×350 | 1024×560 | 1024×768 | 1024×576 | 640×350 |
| VGA | 60/72/75/85/iMac*1 | 640×480/640×360*2 | 1024×768 | 1024×768 | 1024×576 | 640×480 |
| SVGA | 56/60/72/75/85/iMac*1 | 800×600/800×450*2 | 1024×768 | 1024×768 | 1024×576 | 800×600 |
| XGA | 60/70/75/85/iMac*1 | 1024×768/1024×576*2 | 1024×768 | 1024×768 | 1024×576 | 1024×768 |
| WXGA | 60 | 1280×768 | 1024×614 | 1024×768 | 1024×576 | 1024×768 |
| | 60 | 1360×768 | 1024×578 | 1024×768 | 1024×576 | 1024×768 |
| | 60/75/85 | 1280×800 | 1024×640 | 1024×768 | 1024×576 | 1024×768 |
| WXGA+ | 60/75/85 | 1440×900 | 1024×640 | 1024×768 | 1024×576 | 1024×768 |
| SXGA | 70/75/85 | 1152×864 | 1024×768 | 1024×768 | 1024×576 | 1024×768 |
| | 60/75/85 | 1280×1024 | 960×768 | 1024×768 | 1024×576 | 1024×768 |
| | 60/75/85 | 1280×960 | 1024×768 | 1024×768 | 1024×576 | 1024×768 |
| SXGA+ | 60/75/85 | 1400×1050 | 1024×768 | 1024×768 | 1024×576 | 1024×768 |
| UXGA | 60 | 1600×1200 | 1024×768 | 1024×768 | 1024×576 | 1024×768 |
| MAC13" | 67 | 640×480 | 1024×768 | 1024×768 | 1024×576 | 640×480 |
| MAC16" | 75 | 832×624 | 1024×768 | 1024×768 | 1024×576 | 832×624 |
| MAC19" | 75 | 1024×768 | 1024×768 | 1024×768 | 1024×576 | 1024×768 |
| | 60 | 1024×768 | 1024×768 | 1024×768 | 1024×576 | 1024×768 |
| MAC21" | 75 | 1152×870 | 1016×768 | 1024×768 | 1024×576 | 1024×768 |

*1 Connection is disabled if the equipment does not have a VGA output port.

*2 Letterbox signal

Even when signals other than those mentioned above are input, it is likely that the image can be projected. However, not all functions may be supported.

■ Component Video

Units: dots

| Signal | Refresh rate (Hz) | Resolution | Aspect mode | |
|-------------|-------------------|------------------|-------------|----------|
| | | | 4:3 | 16:9 |
| SDTV(480i) | 60 | 720×480/720×360* | 1024×768 | 1024×576 |
| SDTV(576i) | 50 | 720×576/720×432* | 1024×768 | 1024×576 |
| SDTV(480p) | 60 | 720×480/720×360* | 1024×768 | 1024×576 |
| SDTV(576p) | 50 | 720×576/720×432* | 1024×768 | 1024×576 |
| HDTV(720p) | 50/60 | 1280×720 | 1024×768 | 1024×576 |
| HDTV(1080i) | 50/60 | 1920×1080 | 1024×768 | 1024×576 |
| HDTV(1080p) | 50/60 | 1920×1080 | 1024×768 | 1024×576 |

* Letterbox signal

■ Composite video/S-video

Units: dots

| Signal | Refresh rate (Hz) | Resolution | Aspect mode | |
|----------------|-------------------|------------------|-------------|----------|
| | | | 4:3 | 16:9 |
| TV (NTSC) | 60 | 720×480/720×360* | 1024×768 | 1024×576 |
| TV (PAL,SECAM) | 50 | 720×576/720×432* | 1024×768 | 1024×576 |

* Letterbox signal

■ Input signal from the HDMI input port

Units: dots

| Signal | Refresh rate (Hz) | Resolution | Aspect mode | | |
|-------------|-------------------|-------------------------------|-------------|----------|----------|
| | | | 4:3 | 16:9 | Through |
| VGA | 60 | 640×480/640×360 ^{*1} | 1024×768 | 1024×576 | 640×480 |
| SVGA | 60 | 800×600 | 1024×768 | 1024×576 | 800×600 |
| XGA | 60 | 1024×768 | 1024×768 | 1024×576 | 1024×768 |
| WXGA | 60 | 1280×800 | 1024×768 | 1024×576 | 1024×768 |
| SXGA | 60 | 1280×960 | 1024×768 | 1024×576 | 1024×768 |
| | 60 | 1280×1024 | 1024×768 | 1024×576 | 1024×768 |
| SXGA+ | 60 | 1400×1050 | 1024×768 | 1024×576 | 1024×768 |
| UXGA | 60 | 1600×1200 | 1024×768 | 1024×576 | 1024×768 |
| SDTV(480i) | 60 | 720×480/720×360 ^{*1} | 1024×768 | 1024×576 | 640×480 |
| SDTV(480p) | 60 | 720×480/720×360 ^{*1} | 1024×768 | 1024×576 | 640×480 |
| SDTV(576i) | 50 | 720×576/720×432 ^{*1} | 1024×768 | 1024×576 | 768×576 |
| SDTV(576p) | 50 | 720×576/720×432 ^{*1} | 1024×768 | 1024×576 | 768×576 |
| HDTV(720p) | 50/60 | 1280×720 | 1024×768 | 1024×576 | 1024×720 |
| HDTV(1080i) | 50/60 | 1920×1080 | 1024×768 | 1024×576 | 1024×768 |
| HDTV(1080p) | 24/50/60 | 1920×1080 | 1024×768 | 1024×576 | 1024×768 |

*1 Letterbox signal

Supported Monitor Displays for EB-G5200W

■ Computer signals (analog RGB)

Units: dots

| Signal | Refresh rate (Hz) | Resolution | Aspect mode | | | | |
|----------------------|-----------------------------------|---------------------------------|-------------|----------|----------|----------|----------|
| | | | Normal | 16:9 | Full | Zoom | Through |
| VGAEGA | 70 | 640×350 | 1280×700 | 1280×720 | 1280×800 | 1280×700 | 640×350 |
| VGA | 60/72/75/85/iMac ^{*1} | 640×480/640×360 ^{*2} | 1066×800 | 1280×720 | 1280×800 | 1280×800 | 640×480 |
| SVGA | 56/60/72/75/85/iMac ^{*1} | 800×600/800×450 ^{*2} | 1066×800 | 1280×720 | 1280×800 | 1280×800 | 800×600 |
| XGA | 60/70/75/85/iMac ^{*1} | 1024×768/1024×576 ^{*2} | 1066×800 | 1280×720 | 1280×800 | 1280×800 | 1024×768 |
| WXGA | 60 | 1280×768 | 1280×800 | 1280×720 | 1280×800 | 1280×768 | 1280×768 |
| | 60 | 1360×768 | 1280×722 | 1280×720 | 1280×800 | 1280×722 | 1280×768 |
| | 60/75/85 | 1280×800 | 1280×800 | 1280×720 | 1280×800 | 1280×800 | 1280×800 |
| WXGA+ | 60/75/85 | 1440×900 | 1280×800 | 1280×720 | 1280×800 | 1280×800 | 1280×800 |
| WSXGA+ ^{*3} | 60 | 1680×1050 | 1280×800 | 1280×720 | 1280×800 | 1280×800 | 1280×800 |
| SXGA | 70/75/85 | 1152×864 | 1066×800 | 1280×720 | 1280×800 | 1280×800 | 1280×800 |
| | 60/75/85 | 1280×1024 | 1000×800 | 1280×720 | 1280×800 | 1280×800 | 1280×800 |
| | 60/75/85 | 1280×960 | 1066×800 | 1280×720 | 1280×800 | 1280×800 | 1280×800 |
| SXGA+ | 60/75/85 | 1400×1050 | 1066×800 | 1280×720 | 1280×800 | 1280×800 | 1280×800 |
| UXGA | 60 | 1600×1200 | 1066×800 | 1280×720 | 1280×800 | 1280×800 | 1280×800 |
| MAC13 | 67 | 640×480 | 1066×800 | 1280×720 | 1280×800 | 1280×800 | 640×480 |
| MAC16" | 75 | 832×624 | 1066×800 | 1280×720 | 1280×800 | 1280×800 | 832×624 |
| MAC19" | 75 | 1024×768 | 1066×800 | 1280×720 | 1280×800 | 1280×800 | 1024×768 |
| | 60 | 1024×768 | 1066×800 | 1280×720 | 1280×800 | 1280×800 | 1024×768 |
| MAC21" | 75 | 1152×870 | 1066×800 | 1280×720 | 1280×800 | 1280×800 | 1152×800 |

*1 Connection is disabled if the equipment does not have a VGA output port.

*2 Letterbox signal

*3 Only compatible when "Wide" is selected as the "Resolution" from the configuration menu.  p.42

Even when signals other than those mentioned above are input, it is likely that the image can be projected. However, not all functions may be supported.

■ Component Video

Units: dots

| Signal | Refresh rate (Hz) | Resolution | Aspect mode | | | | |
|-------------|-------------------|------------------|-------------|----------|----------|----------|----------|
| | | | Normal | 16:9 | Full | Zoom | Through |
| SDTV(480i) | 60 | 720×480/720×360* | 1066×800 | 1280×720 | 1280×800 | 1280×800 | 640×480 |
| SDTV(576i) | 50 | 720×576/720×432* | 1066×800 | 1280×720 | 1280×800 | 1280×800 | 768×576 |
| SDTV(480p) | 60 | 720×480/720×360* | 1066×800 | 1280×720 | 1280×800 | 1280×800 | 640×480 |
| SDTV(576p) | 50 | 720×576/720×432* | 1066×800 | 1280×720 | 1280×800 | 1280×800 | 768×576 |
| HDTV(720p) | 50/60 | 1280×720 | 1280×720 | 1280×720 | 1280×800 | 1280×720 | 1280×720 |
| HDTV(1080i) | 50/60 | 1920×1080 | 1280×720 | 1280×720 | 1280×800 | 1280×720 | 1280×800 |
| HDTV(1080p) | 50/60 | 1920×1080 | 1280×720 | 1280×720 | 1280×800 | 1280×720 | 1280×800 |

* Letterbox signal

■ Composite video/S-video

Units: dots

| Signal | Refresh rate (Hz) | Resolution | Aspect mode | | | | |
|----------------|-------------------|------------------|-------------|----------|----------|----------|---------|
| | | | Normal | 16:9 | Full | Zoom | Through |
| TV (NTSC) | 60 | 720×480/720×360* | 1066×800 | 1280×720 | 1280×800 | 1280×800 | 640×480 |
| TV (PAL,SECAM) | 50 | 720×576/720×432* | 1066×800 | 1280×720 | 1280×800 | 1280×800 | 768×576 |

* Letterbox signal

■ Input signal from the HDMI input port

Units: dots

| Signal | Refresh rate (Hz) | Resolution | Aspect mode | | | |
|-------------|-------------------|-------------------------------|-------------|----------|----------|----------|
| | | | 16:9 | Full | Zoom | Through |
| VG | 60 | 640×480/640×360 ^{*1} | 1280×720 | 1280×800 | 1280×800 | 640×480 |
| SVGA | 60 | 800×600 | 1280×720 | 1280×800 | 1280×800 | 800×600 |
| XGA | 60 | 1024×768 | 1280×720 | 1280×800 | 1280×800 | 1024×768 |
| WXGA | 60 | 1280×800 | 1280×720 | 1280×800 | 1280×800 | 1280×800 |
| SXGA | 60 | 1280×960 | 1280×720 | 1280×800 | 1280×800 | 1280×800 |
| | 60 | 1280×1024 | 1280×720 | 1280×800 | 1280×800 | 1280×800 |
| SXGA+ | 60 | 1400×1050 | 1280×800 | 1280×800 | 1280×800 | 1280×800 |
| UXGA | 60 | 1600×1200 | 1280×720 | 1280×800 | 1280×800 | 1280×800 |
| SDTV(480i) | 60 | 720×480/720×360 ^{*1} | 1280×720 | 1280×800 | 1280×800 | 640×480 |
| SDTV(480p) | 60 | 720×480/720×360 ^{*1} | 1280×720 | 1280×800 | 1280×800 | 640×480 |
| SDTV(576i) | 50 | 720×576/720×432 ^{*1} | 1280×720 | 1280×800 | 1280×800 | 768×576 |
| SDTV(576p) | 50 | 720×576/720×432 ^{*1} | 1280×720 | 1280×800 | 1280×800 | 768×576 |
| HDTV(720p) | 50/60 | 1280×720 | 1280×720 | 1280×800 | 1280×720 | 1280×720 |
| HDTV(1080i) | 50/60 | 1920×1080 | 1280×720 | 1280×800 | 1280×720 | 1280×800 |
| HDTV(1080p) | 24/50/60 | 1920×1080 | 1280×720 | 1280×800 | 1280×720 | 1280×800 |

*1 Letterbox signal

Projector General Specifications

| | | | | | |
|-------------------------------|---|---|---------------------------------------|---|---------------------------------------|
| Product name | EB-G5350 | EB-G5300 | EB-G5150 | EB-G5100 | EB-G5200W |
| Dimensions ^{*1} | 470 (W) × 135 (H) × 311.5 (D) mm (not including foot and projection lens) | | | | |
| Panel size | 0.8" | | | 0.74" wide | |
| Display method | Polysilicon TFT active matrix | | | | |
| Resolution | 786,432 pixels XGA (1024 (W) × 768 (H) dots) × 3 | | | 1,024,000 pixels WXGA (1280 (W) × 800 (H) dots) × 3 | |
| Focus adjustment | Manual | | | | |
| Zoom adjustment ^{*1} | Manual (1 to 1.8) | | | | |
| Lamp | UHE lamp, 275 W Model No.: ELPLP46 | | UHE lamp, 210 W Model No.: ELPLP47 | | UHE lamp 275 W, Model No.: ELPLP46 |
| Max. audio output | 7 W monaural | | | | |
| Speaker | 1 | | | | |
| Power supply | 100 to 240 V AC ±10%, 50/60 Hz 3.8-1.7A | | | | |
| Power consumption | 100 to 120 V area | Operating: 423 W Standby power consumption (network invalid): 0.4 W Standby power consumption (network valid): 10 W | | Operating: 343 W Standby power consumption (network invalid): 0.4 W Standby power consumption (network valid): 10 W | |
| | 220 to 240 V area | Operating: 398 W Standby power consumption (network invalid): 0.6 W Standby power consumption (network valid): 12 W | | Operating: 327 W Standby power consumption (network invalid): 0.6 W Standby power consumption (network valid): 12 W | |
| Operating altitude | Altitude 0 to 3,000 m (0 to 98,438 ft) | | | | |
| Operating temperature | 0+40 ^{*2} (No condensation) | | | | |
| Storage temperature | -10 to +60 (No condensation) | | | | |
| Volume ^{*1} | Approx 6.8kg | | | | |

*1 The specifications are when a standard lens is attached. When an optional lens is attached, check the "Optional User's Guide" supplied with the optional lenses.

*2 When "Brightness Control" is set to "High Brightness" at an altitude of 1500 to 3000 m and a temperature of 0 to +35

This product is also designed for IT power distribution system with phase-to-phase voltage 230V.

| Product name | | EB-G5350 | EB-G5300 | EB-G5150 | EB-G5100 | EB-G5200W |
|--------------|---------------------------------|-------------------------|---------------------------------|----------|------------------------|-----------|
| Connectors | Computer1 input port | 1 | Mini D-Sub15-pin (female) blue | | | |
| | Computer2 input port | 1 | Mini D-Sub15-pin (female) blue | | | |
| | BNC input port | 1 | 5BNC (female) | | | |
| | Audio-L/R input port | 1 | Stereo mini jack | | | |
| | Video1 input port | 1 | 1BNC (female) | | | |
| | Video2 input port | 1 | RCA pin jack | | | |
| | S-Video input port | 1 | Mini DIN 4-pin | | | |
| | Audio-L/R input port | 1 | RCA pin jack ×2 (L, R) | | | |
| | HDMI input port | 1 | HDMI | | | |
| | Monitor Out port | 1 | Mini D-Sub15-pin (female) black | | | |
| | Audio Out port | 1 | Stereo mini jack | | | |
| | LAN port | 1 | RJ-45 | | | |
| | USB port (Type A) ^{*3} | 1 | USB connector (Type A) | - | USB connector (Type A) | - |
| | USB port (Type B) ^{*3} | 1 | USB connector (Type B) | - | USB connector (Type B) | - |
| | Card slot | 1 | SD card × 1 | - | SD card × 1 | - |
| RS-232C port | 1 | Mini D-Sub 9-pin (male) | | | | |
| Remote port | 1 | Stereo mini jack | | | | |

*3 This supports USB2.0.USB ports are not guaranteed to operate all devices that support USB.



Pixelworks DNX™ ICs are used in this projector.



SDHC Logo is a trademark.

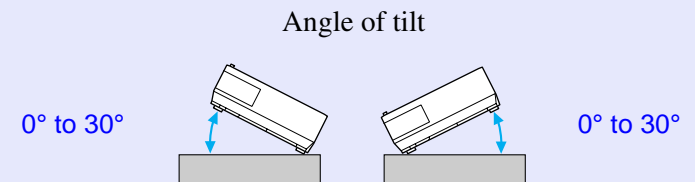

If you use the projector tilted at an angle of more than 30° it could be damaged and cause an accident.

Operating Conditions for the Supplied Software

The software supplied with the projector runs on computers that meet the following requirements.
EMP NS Connection, EMP SlideMaker2, and USB Display are only supplied with EB-G5350/G5150.

| | EMP NS Connection | EMP SlideMaker2* | EMP Monitor | USB Display |
|-------------------------|--|--|---|---|
| OS | Windows 2000 SP4/XP/ XP SP1/XP SP2/Vista Mac OS X 10.3 or later Recommended: Mac OS 10.5.1 or later, 10.4.11/10.3.9 | Windows 98/98 SE/Me/2000 SP4/ XP/XP SP1/XP SP2/Vista | Windows 98 SE SP1/Me/NT4.0 SP6/2000 SP4/ XP 32Bit edition (Home Edition/ Professional) SP1 or later/ Vista Internet Explorer Ver.5 or later | Windows 2000 SP4/XP/ XP SP1/XP SP2/Vista |
| CPU | Mobile Pentium III 1.2 GHz or faster Power PC G3 900 MHz or faster Recommended: Pentium M 1.6 GHz or faster Core Duo 1.5GHz or faster | Celeron 300 MHz or faster Recommended: Celeron 400 MHz or faster | Pentium MMX 166 MHz or faster Recommended: Pentium II 233 MHz or faster | Mobile Pentium III 1.2 GHz or faster Recommended: Pentium M 1.6 GHz or faster |
| Amount of Memory | 256 MB or more Recommended: 512 MB or more | 64 MB or more Recommended: 128 MB or more | 64 MB or more | 256 MB or more Recommended: 512 MB or more |
| Hard Disk Free space | 20 MB or more | 12 MB or more | 50 MB or more | 20 MB or more |
| Display | Resolution greater than XGA (1024 × 768) Display color of approx. 32000 colors more than 16 bit colors | | Resolution greater than SVGA (800 × 600) Display color in 32 bit full-color or greater | Resolution greater than XGA (1024 × 768) Display color of approx. 32000 colors more than 16 bit colors |

* When using a PowerPoint file, you need either Office 2000/XP/2003/2007 or PowerPoint 2000/2002/2003/2007.

**DECLARATION of CONFORMITY**

According to 47CFR, Part 2 and 15
Class B Personal Computers and Peripherals; and/or
CPU Boards and Power Supplies used with Class B
Personal Computers

We: Epson America, Inc.
Located at: 3840 Kilroy Airport Way
MS: 3-13
Long Beach, CA 90806
Tel: 562-290-5254

Declare under sole responsibility that the product identified herein, complies with 47CFR Part 2 and 15 of the FCC rules as a Class B digital device. Each product marketed, is identical to the representative unit tested and found to be compliant with the standards. Records maintained continue to reflect the equipment being produced can be expected to be within the variation accepted, due to quantity production and testing on a statistical basis as required by 47CFR 2.909. Operation is subject to the following two conditions :

Trade Name: EPSON
Type of Product: Projector
Model :H272C/H273C/H278C/H286C/H298C/H299C

**FCC Compliance Statement
For United States Users**

This equipment has been tested and found to comply with the limits for a Class B digital device, pursuant to Part 15 of the FCC Rules. These limits are designed to provide reasonable protection against harmful interference in a residential installation. This equipment generates, uses, and can radiate radio frequency energy and, if not installed and used in accordance with the instructions, may cause harmful interference to radio or television reception. However, there is no guarantee that interference will not occur in a particular installation. If this equipment does cause interference to radio and television reception, which can be determined by turning the equipment off and on, the user is encouraged to try to correct the interference by one or more of the following measures.

- Reorient or relocate the receiving antenna.
- Increase the separation between the equipment and receiver.
- Connect the equipment into an outlet on a circuit different from that to which the receiver is connected.
- Consult the dealer or an experienced radio/TV technician for help.

WARNING

The connection of a non-shielded equipment interface cable to this equipment will invalidate the FCC Certification or Declaration of this device and may cause interference levels which exceed the limits established by the FCC for this equipment. It is the responsibility of the user to obtain and use a shielded equipment interface cable with this device. If this equipment has more than one interface connector, do not leave cables connected to unused interfaces. Changes or modifications not expressly approved by the manufacturer could void the user's authority to operate the equipment.

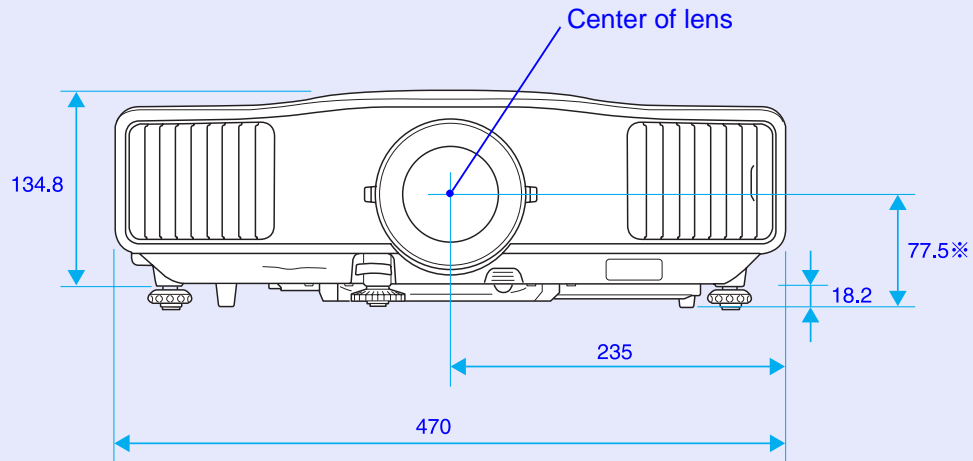

* Distance from center of lens to suspension bracket fixing point

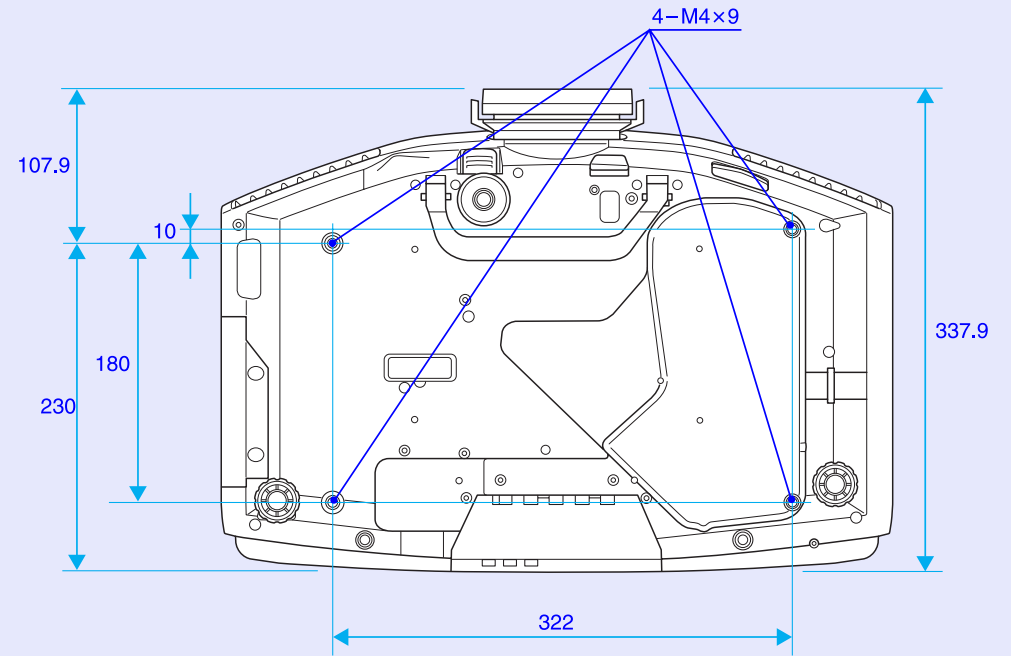

Units: mm

This section explains easily terms that are used with the projector and difficult terms that are not explained in the text of this guide. For details, refer to other commercially available publications.

| | |
|----------------------|---|
| AMX Device Discovery | AMX Device Discovery is a technology developed by AMX to facilitate AMX control systems for easy operation of the target equipment. Epson have implemented this protocol technology, and have provided a setting to enable the protocol function (ON). See the AMX Web site for more details. URL http://www.amx.com/ |
| Aspect ratio | The ratio between an image's length and its height. HDTV images have an aspect ratio of 16:9 and appear elongated. The aspect ratio for standard images is 4:3. |
| Component Video | A video signal which has the luminance component and color component separated to provide better image quality. Refers to images that consist of three independent signals: Y (luminance signal), Pb and Pr (color difference signals). |
| Composite video | Video signals that have the video brightness signals and color signals mixed together. The type of signals commonly used by household video equipment (NTSC, PAL, and SECAM formats). The carrier signal Y (luminance signal) and chroma (color) signal that are contained in the color bar are overlapped to form a single signal. |
| Contrast | The relative brightness of the light and dark areas of an image can be increased or decreased to make text and graphics stand out more clearly, or to make them appear softer. Adjusting this particular property of an image is called "contrast adjustment". |
| DHCP | An abbreviation of Dynamic Host Configuration Protocol, this protocol automatically assigns an IP address to equipment connected to a network. |
| Dolby Digital | A sound format developed by Dolby Laboratories. Normal stereo is a 2-channel format that uses two speakers. Dolby Digital is a 6-channel (5.1-channel) system which adds to this a center speaker, two rear speakers, and a sub-woofer. |
| Gateway address | This is a server (router) for communicating across a network (subnet) divided according to subnet masks . |
| HDTV | An abbreviation for High-Definition Television that refers to high-definition systems which satisfy the following conditions. <ul style="list-style-type: none"> • Vertical resolution of 720p or 1080i or greater (p = progressive, i = interlace) • Screen aspect ratio of 16:9 • Dolby Digital audio reception and playback (or output) |
| Interlace | A method of image scanning whereby the image data is divided into fine horizontal lines that are displayed in sequence starting from left to right and then from top to bottom. The even-numbered lines and odd-numbered lines are displayed alternately. |
| IP address | A number to identify a computer connected to a network. |
| Progressive | A method of image scanning whereby the image data from a single image is scanned sequentially from top to bottom to create a single image. |

| | |
|----------------------|---|
| Refresh rate | The light-emitting element of a display maintains the same luminosity and color for an extremely short time. Because of this, the image must be scanned many times per second to refresh the light-emitting element. The number of refresh operations per second is called the Refresh rate and is expressed in hertz (Hz). |
| SDTV | An abbreviation for Standard Definition Television that refers to standard television systems which do not satisfy the conditions for <u>HDTV</u> High-Definition Television. |
| SNMP | An abbreviation for Simple Network Management Protocol, which is the protocol for monitoring and controlling devices such as routers and computers connected to a TCP/IP network. |
| SNMP Trap IP address | This is the <u>IP address</u> for the destination computer used for error notification in SNMP. |
| Squeeze mode | In this mode, wide-screen images in 16:9 mode are compressed in the horizontal direction so that they are stored on the recording medium as 4:3 images. When these images are played back by the projector in squeeze mode, they are restored to their original 16:9 format. |
| sRGB | An international standard for color intervals that was formulated so that colors that are reproduced by video equipment can be handled easily by computer operating systems (OS) and the Internet. If the connected source has an sRGB mode, set both the projector and the connected signal source to sRGB. |
| SSID | SSID is an identification number for connecting with a counterpart on a wireless LAN. Wireless communication is possible between devices that correspond to SSID. |
| Subnet mask | This is a numerical value that defines the number of bits used for the network address on a divided network (subnet) from the IP address. |
| SVGA | A type of video signal with a resolution of 800 (horizontal) × 600 (vertical) dots that is used by IBM PC/AT-compatible computers. |
| S-Video | A video signal which has the luminance component and color component separated to provide better image quality. Refers to images that consist of two independent signals: Y (luminance signal) and C (color signal). |
| SXGA | A type of video signal with a resolution of 1,280 (horizontal) × 1,024 (vertical) dots that is used by IBM PC/AT-compatible computers. |
| Synchronization | The signals output from computers have a specific frequency. If the projector frequency does not match this frequency, the resulting images are not of a good quality. The process of matching the phases of these signals (the relative position of the crests and the troughs in the signal) is called Synchronization. If the signals are not synchronized, flickering, blurriness, and horizontal interference occur. |
| Tracking | The signals output from computers have a specific frequency. If the projector frequency does not match this frequency, the resulting images are not of a good quality. The process of matching the frequency of these signals (the number of crests in the signal) is called Tracking. If tracking is not carried out correctly, wide vertical stripes appear in the signal. |
| VGA | A type of video signal with a resolution of 640 (horizontal) × 480 (vertical) dots that is used by IBM PC/AT-compatible computers. |
| WPS | WPS is an abbreviation of Wi-Fi Protected Setup. Wi-Fi Protected Setup has been devised by the Wi-Fi Alliance as a means of easily setting up and securing a wireless LAN. |
| XGA | A type of video signal with a resolution of 1,024 (horizontal) × 768 (vertical) dots that is used by IBM PC/AT-compatible computers. |

A

| | |
|-------------------------------------|-----|
| A/V mute | 22 |
| Abs. Color Temp. | 41 |
| Air exhaust vent | 7 |
| Air filter replacement period | 88 |
| Angle of tilt | 123 |
| Audio Out port | 11 |
| Audio-L/R input port | 10 |
| Auto Setup | 42 |

B

| | |
|--------------------------|----|
| Basic Menu | 52 |
| Blackboard | 21 |
| BNC input port | 10 |
| Brightness | 41 |
| Brightness control | 44 |

C

| | |
|---|--------|
| Ceiling | 46 |
| Ceiling mount fixing points | 9, 126 |
| Cleaning the air filter and air intake vent | 81 |
| Cleaning the projector's surface | 81 |
| Color Adjustment | 41 |
| Color Mode | 21, 41 |
| Color Saturation | 41 |
| Computer1 input port | 10 |
| Computer2 input port | 11 |
| Configuration menu | 40 |
| Connecting a LAN Cable | 107 |
| Connecting USB Devices | 104 |
| Consumables | 91 |
| Contrast | 41 |
| Control panel | 12 |
| Control Panel Lock | 36, 44 |
| Cross | 28 |

D

| | |
|--------------------------|--------|
| DHCP | 48, 53 |
| Direct Power On | 47 |
| Display | 46 |
| Display background | 46 |

E

| | |
|-----------------------------------|-----|
| Email Address 1/2/3 | 60 |
| Email Address 1/2/3 setting | 49 |
| ESC/VP21 | 112 |
| Extended menu | 46 |
| External dimension diagram | 126 |
| External monitor | 101 |
| External speakers | 101 |
| E-zoom | 28 |

F

| | |
|-----------------------------|----|
| Freeze | 22 |
| Front | 46 |
| Front adjustable foot | 7 |
| Full lock | 36 |

G

| | |
|-----------------------|------------|
| Game | 21 |
| Gateway address | 48, 53, 59 |

H

| | |
|-------------------------------------|----|
| HDMI input port | 11 |
| Help function | 66 |
| High altitude mode: | 47 |
| How to replace the air filter | 88 |
| How to replace the lamp | 85 |

I

| | |
|--------------------|------------|
| Image menu | 41 |
| Indicators | 67 |
| Info menu | 63 |
| Input signal | 63 |
| IP address | 48, 53, 60 |

K

| | |
|----------------|----|
| Keystone | 44 |
|----------------|----|

L

| | |
|-------------------------------|----|
| Lamp cover | 7 |
| Lamp hours | 63 |
| Lamp indicator | 67 |
| Lamp replacement period | 85 |
| LAN port | 10 |
| Language | 47 |
| Low Brightness | 44 |

M

| | |
|-------------------------------------|--------|
| MAC Address | 48 |
| Mail | 49 |
| Mail Menu | 60 |
| Mail Notification function | 49, 60 |
| Menu | 40 |
| Messages | 46 |
| Monitor Out port | 11 |
| Multi-Screen Color Adjustment | 32 |

N

| | |
|------------------------------|--------|
| Network drive password | 52 |
| Network Menu | 48, 50 |
| Network Projector | 114 |
| Network Protect | 35 |

O

| | |
|-----------------------------|-----|
| Operating temperature | 122 |
| Operation | 47 |
| Optional accessories | 90 |
| Overheating | 68 |

P

| | |
|--------------------------------|--------|
| Part names and functions | 7 |
| Password protect | 34 |
| Password protect sticker | 34 |
| Photo | 21 |
| PJLink | 115 |
| PJLink Password | 48 |
| Pointer | 27 |
| Pointer shape | 44 |
| Port Number | 49, 60 |
| Position | 42 |
| Power indicator | 67 |
| Power inlet | 10 |
| Power on protect | 34 |
| Presentation | 21 |
| Problem solving | 67 |
| Progressive | 42 |
| Projection | 46 |
| Projection distance | 99 |
| Projector ID | 30 |
| Projector name | 49, 52 |

R

| | |
|---------------------------|----|
| Rear | 46 |
| Rear foot | 9 |
| Rear screen | 80 |
| Refresh rate | 63 |
| Remote control | 13 |
| Remote Receiver | 7 |
| Replacing batteries | 84 |
| Request code | 36 |

| | |
|---|---------|
| Reset all | 64 |
| Reset Menu | 64 |
| Resetting the lamp operating time | 64, 87 |
| Resolution | 63, 116 |

S

| | |
|----------------------------------|------------|
| Screen size | 99 |
| SD card slot | 10 |
| SD memory card | 105 |
| Security Menu | 55 |
| Security slot | 10 |
| Settings menu | 44 |
| Sharpness | 41 |
| Signal menu | 42 |
| Sleep mode | 47 |
| SMTP server | 49, 60 |
| SNMP | 49 |
| SNMP Menu | 61 |
| SNMP Trap IP address | 61 |
| Software keyboard | 49, 51 |
| Source | 63 |
| Source search | 12, 19 |
| Speaker | 101 |
| Specifications | 122 |
| Sports | 21 |
| sRGB | 21 |
| SSID | 53 |
| Standby mode | 47 |
| Startup screen | 46 |
| Storage temperature | 122 |
| Sub Menu | 40 |
| Subnet mask | 48, 53, 59 |
| Supported monitor displays | 116 |
| S-Video input port | 10 |
| Sync info | 63 |
| Synchronization | 42 |

T

| | |
|-----------------------|----|
| Temp indicator | 67 |
| Theatre | 21 |
| Tint | 41 |
| Top menu | 40 |
| Tracking | 42 |
| Trap IP Address | 49 |

U

| | |
|---------------------------|----|
| User's logo | 93 |
| User's logo protect | 34 |

V

| | |
|----------------------------|--------|
| Video signal | 43, 63 |
| Video 1/2 input port | 10 |
| Volume | 44 |

W

| | |
|------------------------------|----|
| Web Control Password | 48 |
| Wide-screen projection | 23 |
| Wired LAN | 48 |
| Wired LAN Menu | 59 |
| Wireless LAN Menu | 53 |

Z

| | |
|-----------------|---|
| Zoom ring | 7 |
|-----------------|---|

All rights reserved. No part of this publication may be reproduced, stored in a retrieval system, or transmitted in any form or by any means, electronic, mechanical, photocopying, recording, or otherwise, without the prior written permission of Seiko Epson Corporation. No patent liability is assumed with respect to the use of the information contained herein. Neither is any liability assumed for damages resulting from the use of the information contained herein.

Neither Seiko Epson Corporation nor its affiliates shall be liable to the purchaser of this product or third parties for damages, losses, costs, or expenses incurred by the purchaser or third parties as a result of: accident, misuse, or abuse of this product or unauthorized modifications, repairs, or alterations to this product, or (excluding the U.S.) failure to strictly comply with Seiko Epson Corporation's operating and maintenance instructions.

Seiko Epson Corporation shall not be liable against any damages or problems arising from the use of any options or any consumable products other than those designated as Original Epson Products or Epson Approved Products by Seiko Epson Corporation.

The contents of this guide may be changed or updated without further notice.

Illustrations in this guide and the actual projector may differ.

General Notice:

IBM, DOS/V, and XGA are trademarks or registered trademarks of International Business Machines Corporation.
Macintosh, Mac, and iMac are registered trademarks of Apple Inc.
Windows, WindowsNT, Windows Vista, and PowerPoint are trademarks or registered trademarks of Microsoft Corporation in the United States.
Dolby is a trademark of Dolby Laboratories.
Pixelworks and DNX are trademarks of Pixelworks Inc.
HDMI and High-Definition Multimedia Interface are the trademarks or registered trademarks of HDMI Licensing LLC. **HDMI**[™]
HIGH DEFINITION MULTIMEDIA INTERFACE

This product includes RSA[®] BSAFE[™] Cryptographic software from RSA Security Inc. RSA is a registered trademark of RSA Security Inc. BSAFE RSA Security Inc. is a registered trade mark in the United States and other countries.

This product includes **NetNucleus**[®] **WPA** Cryptographic software from TOSHIBA INFORMATION SYSTEMS CORPORATION.

NetNucleus is a registered trademark of TOSHIBA INFORMATION SYSTEMS CORPORATION in Japan.

Other product names used herein are also for identification purposes only and may be trademarks of their respective owners. Epson disclaims any and all rights in those marks.